

TUBI TERMOPLASTICI  
SETTORE INDUSTRIALE  
ZEC



 HYDRAULIC  
COMPONENTS  
& FLUID CONTAMINATION  
CONTROL



All trademarks belong to their respective owners; third party trademarks, product names, trade names, corporate names and company names mentioned may be trademarks of their respective owners or registered trademarks of other companies and are used for instructional purposes and for the benefit of the owner, without any end of Copyright infringement in force.

Tutti i marchi riportati appartengono ai legittimi proprietari; marchi di terzi, nomi di prodotti, nomi commerciali, nomi corporativi e società citati possono essere di proprietà dei rispettivi titolari o registrati da altre società e sono stati utilizzati a puro scopo esplicativo e a beneficio del possessore, senza alcun fine di violazione dei diritti di Copyright vigenti.



## INDUSTRIA / GENERAL INDUSTRY



Tubi termoplastici per il settore industriale  
*Thermoplastic Hoses for General Industry*



THERMOPLASTIC TUBING AND HOSES



GENERAL INDUSTRY



















## Indice / Index

Azienda / Company .....	6
Applicazioni / Applications .....	8
Certificazioni / Certifications .....	12
Soluzione termoplastica: 10 vantaggi importanti / Thermoplastic solution: 10 important advantages .....	14
Settori applicativi / Application areas .....	16
Indice riassuntivo dei tubi / Hose visual index .....	18
Tabella di selezione / Hose selection table .....	22
Codifica tubi e opzioni / Hose coding and options .....	24

## Soluzioni per vernici, solventi ed iniezione Solutions for Paint Spray, Solvents, Injection













26

	VE5 .....	28
	VE5P-PA .....	29
	VE7 .....	30
	AS7 .....	31
	VE7M .....	32
	VE8 .....	33
	AS8 .....	34
	VE8M .....	35
	MT1 .....	36
	MT1E .....	37
	MT1-PA .....	38
	MT2 .....	39
	MT2Y .....	40
	MTK .....	41

	MTKM .....	42
	VE5+PU .....	43
	MT1+PA.....	44

## Soluzioni per la gestione di gas industriali *Solutions for Gas Handling*

46

	GAS5 CONDUCTIVE .....	48
	CNG .....	49
	HOG .....	50
	AT7 .....	51
	AT8 .....	52
	AT8S .....	53
	AT8S-FEP .....	54
	MTHAT1 .....	55
	MTHAT2 .....	56
	MTK-CO .....	57
	CO <sub>2</sub> SYSTEM .....	58
	OL5FLPU FLEX-FLOW .....	59

## Soluzioni per applicazioni ad alta temperatura *Solutions for High Temperature Applications*

60

	MT1HT-PTFE .....	62
	PTFEIP .....	63



PTFEIM .....64



PTFEIG .....65



PTFEI2T .....66



PTFEIC .....67



TICI .....68

**Accessori / Accessories** **70**

**Indicazioni di montaggio / Installation instructions** **78**

## ZEC S.p.A.: Flessibilità per scelta

ZEC S.p.A., fondata nel 1961 da Eugenio Zantelli a Colorno, in provincia di Parma, produce tubi termoplastici per applicazioni a bassa, media, alta e altissima pressione.

A partire dal 1990 le attività commerciali sul mercato domestico sono estese all'espansione sui mercati internazionali.

Investimenti in risorse umane particolarmente qualificate, impianti di produzione tecnologicamente avanzati, attività di ricerca e sviluppo e la presenza commerciale favoriscono l'espansione sui mercati globali, dove ZEC S.p.A. oggi è presente in più di 90 paesi.

La considerevole crescita in tutte le aree è stata accompagnata da una gamma di prodotti sempre più ampia, dedicata a numerosi settori applicativi, quali oleodinamica, pneumatica, lubrificazione, automotive, alimentare, navale, refrigerazione, petrochimico-offshore, etc..

La gamma di prodotti di ZEC S.p.A. comprende tubi termoplastici standard o customizzati singoli, multipli e spiraliati, con caratteristiche tecniche da 2mm a 40mm di diametro interno, pressioni di lavoro da 5bar a 1280bar e temperature di esercizio da -200°C a +260°C.

Tutti i tubi termoplastici di ZEC S.p.A. sono prodotti di materie prime di primaria qualità accuratamente selezionate. Ogni fase del ciclo produttivo è soggetta a severi controlli qualitativi.

La produzione avviene esclusivamente all'interno dei ns. stabilimenti a Colorno, Italia.

I prodotti finiti sono conformi alle principali normative internazionali dei rispettivi settori applicativi, quali SAE, EN, ISO e DIN.

ZEC S.p.A. opera in regime di qualità UNI EN ISO 9001-2015.

## ZEC S.p.A.: Flexibility for Choice

*ZEC S.p.A., founded in 1961 by Mr. Eugenio Zantelli in Colorno, Province of Parma, Italy, manufactures thermoplastic tubing and hoses for low, medium, high and very high pressure applications.*

*Domestic business activities are boosted by an International breakthrough as of 1990.*

*Investments in special skilled human resources, manufacturing, product innovations and commercial presence elevates ZEC S.p.A. meanwhile into the global market, covering more than 90 countries world-wide.*

*Significant growth in all areas have been accompanied with an ever increasing product range dedicated to a large portfolio of applications such as fluid power, pneumatics, lubrication, automotive, food processing, marine, refrigeration, petrochemical-offshore, and so on.*

*The ZEC S.p.A. product range includes standard or customized single, multiple and coiled thermoplastic tubing and hoses, with technical characteristics within the range of 2mm to 40mm inner diameter, working pressures from 5bar to 1280bar and operating temperatures from -200°C to +260°C.*

*All products manufactured by ZEC S.p.A. are of top quality and carefully selected raw materials. Manufacturing processes are continuously multiple controlled.*

*The entire production takes place in our facilities located in Colorno, Italy.*

*End products comply strictly with major international standards such as SAE, EN, DIN & ISO.*

*All company sectors and activities are qualified and operate according to UNI EN ISO 9001-2015 quality system.*



General Industry

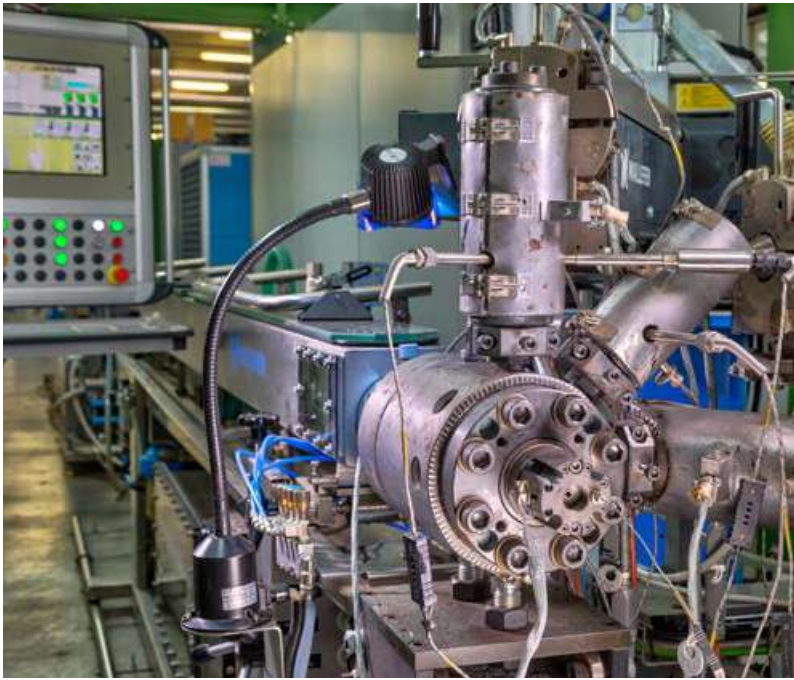
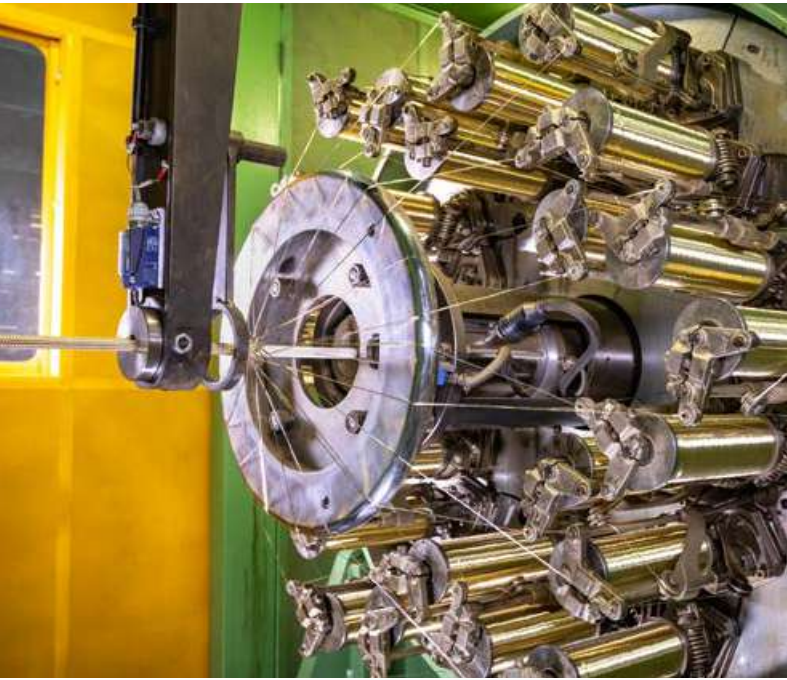

## Le soluzioni ZEC per il settore industriale

I tubi termoplastici ZEC trovano vasta applicazione in diversi settori industriali. Sono la soluzione ideale per il passaggio di oli, fluidi idraulici, polioli, solventi, vernici e gas compatibili, anche ad alta pressione. Vi sono inoltre soluzioni idonee al passaggio di fluidi alimentari.

### APPLICAZIONI

I tubi termoplastici ZEC, per il settore industriale, sono utilizzabili in un vasto numero di applicazioni. Solo per citarne alcune:

- Soluzioni con detergenti
- Solventi e polioli
- Verniciatura standard ed anti-statica
- Iniezione di poliuretano e schiumatura
- Gestione Gas Naturale
- Gestione Gas GPL - Stazioni di rifornimento
- Aria respirabile
- Gas vari
- Gestione CO2 antincendio
- Alta temperatura fino a 260°C
- Autoestinguento e anti scintilla



### NORMATIVE

I prodotti ZEC elencati in questa brochure sono conformi o superiori alle normative **SAE J517-100R7 - 100R8 - 100R18 - 100R1 - 100R2, EN 853 1ST - 1SN, EN 857 1SC, ISO 3949**, ed in alcuni casi progettati e costruiti in accordo a **ISO 13628-5, API 17E**.

A livello industriale non sono presenti normative specifiche rispetto ai fattori di sicurezza dei tubi in pressione; in molti casi il fattore di sicurezza più comune su applicazioni industriali e quindi statiche è di 3:1.

Per agevolare il cliente, diverse serie di prodotti (utilizzati anche in applicazioni oleodinamiche) riportano la doppia marcatura: **STATIC WP (SF 3:1) e DYNAMIC WP (SF 4:1)**.



Il cliente è responsabile di verificare che la sua applicazione soddisfi tutte le condizioni e le specifiche indicate nella normativa di riferimento.

### QUALITÀ

Il sistema di qualità certificato **ISO 9001:2015 di ZEC** assicura un continuo e costante controllo del processo di produzione, garantendo il rispetto delle buone pratiche di fabbricazione.



*General Industry*



## ZEC solutions for industrial applications

ZEC thermoplastic tubing and hoses are suitable for a wide range of industrial applications. They are the ideal solution for the conduction of oils, hydraulic fluids, polyols, solvents, paints and compatible gases, also at high pressure. They are suitable for applications in food and beverage industries.

**APPLICATIONS** ZEC hoses are used in a wide range of Industrial applications, a few examples below:

- Solvents
  - Solutions with detergents
  - Standard and anti-static paint spray
  - Polyurethane Injection and foaming
  - Natural Gas Handling (CNG)
  - LPG Gas Station
  - Gas applications
  - Breathing Air solutions
  - CO<sub>2</sub> - fire extinguishing
  - High temperature - Up to 260°C
  - Self-extinguishing and spark proof
- 

**STANDARDS** ZEC products listed below are compliant with **SAE J517-SAE 100R7 - 100R8 - 100R18 - 100R1 - 100R2, EN 853 1ST - 1SN, EN 857 1SC, ISO 3949**, some items manufactured in accordance to **ISO13628-5, API 17E**.

There are no specific standards regulating Pressure Safety Factor on industrial applications; The most common safety factor required is 3:1, typical on static applications. To facilitate our customers, few hose series (used on fluid power applications too) bear the double WP marking: **STATIC WP (SF 3:1) and DYNAMIC WP (SF 4:1)**.



The customer is responsible to check that his application meets all the conditions and specifications outlined in accordance with the proper standard.

**QUALITY** The certified **ISO 9001:2015 ZEC** quality system ensures a continuous and constant control of the production process, guaranteeing compliance with good manufacturing practices.







# CERTIFICATIONS

ZEC supplies high quality products to its customers, following European and international regulations.

All ZEC hoses are manufactured in conformity to **European Regulation CE 1907/2006 "REACH"** and **European Directive EU 2011/65 "RoHS"**.

Declarations are available at following page: [www.zecspa.com/en/technical-support](http://www.zecspa.com/en/technical-support).



ZEC holds **MSHA – Mine Safety and Health Administration** ([www.msha.gov](http://www.msha.gov)) certifications for a large range of products, as guarantee to required material selection in use, also in mining.



## OTHER CERTIFICATIONS

10 product ranges, in accordance to:

- **DNVGL – OS – D101**
- **DNVGL – CP – 0183**
- **DNV TAP00002C3 (CO2 Systems)**



These and other Certifications on specific products, as well as Declarations of Conformity, together with other technical documents, manuals and instructions, various modules are available on our Reserved Area:

[www.zecspa.com/en/reserved-area](http://www.zecspa.com/en/reserved-area).



## Soluzione termoplastica: 10 VANTAGGI IMPORTANTI

### Thermoplastic solution: 10 IMPORTANT ADVANTAGES

I materiali e la tecnologia che stanno dietro la produzione dei tubi ZEC conferiscono ai prodotti finiti importanti vantaggi rispetto soprattutto ai tradizionali tubi flessibili in gomma:

*The materials and technology behind the production of ZEC tubing and hoses, provide important advantages to finished products, especially compared to traditional rubber hoses:*



#### **Elevata resistenza all'abrasione**

##### **High abrasion resistance**

La copertura esterna assicura un'elevata resistenza all'abrasione. In particolare l'utilizzo di additivi e materiali scivolanti, nonché soluzioni di adesione della ricopertura, conferiscono ai tubi termoplastici una durata di vita superiore a quelli tradizionali in gomma.

*The external covering ensures high abrasion resistance. In particular the use of additives and sliding materials, as well as covering's adhesion solutions, ensure a longer service life of thermoplastic hoses compared to that of traditional rubber solutions.*



#### **Leggerezza e non conduttività**

##### **Light weight and non conductivity**

Il rinforzo in fibra tessile o ibrida conferisce ai tubi termoplastici una notevole leggerezza, senza ridurne la resistenza alla pressione (riduzione di peso fino a 70% rispetto alla gomma). Inoltre i tubi con rinforzo tessile sono gli unici che rispondono allo standard ANSI A92.2.

*Reinforcement made of textile or hybrid fibers makes the thermoplastic hose remarkably light, without reducing its pressure resistance (weight reduction up to 70% compared to rubber). Furthermore textile braided thermoplastic hoses are the only ones meeting the ANSI A92.2 standard.*



#### **Resistenza agli agenti atmosferici / durata a magazzino**

##### **Resistance to environmental agents / long shelf-life**

La copertura esterna in materiali antiabrasione, stabilizzata ai raggi UV e resistente all'idrolisi e ai microrganismi, rende i tubi termoplastici adatti anche ad applicazioni all'esterno, in ambienti particolarmente umidi e salini, con alte e basse temperature. Inoltre è una garanzia di stabilità nel tempo, anche a magazzino.

*External cover in antiabrasion materials, UV rays stabilized and resistant to hydrolysis and micro-organisms, makes thermoplastic hoses suitable for outdoor applications, in extremely humid and saline environments, and high and low temperatures. It also ensures a guarantee for long term shelf-life.*



#### **Elevata resistenza chimica**

##### **High chemical resistance**

L'utilizzo di diversi materiali per le anime interne dei tubi, consente poi l'impiego anche con oli, emulsioni e polioli particolarmente aggressivi. (V. tabella di compatibilità chimica disponibile su: [www.zecspa.com/it/supporto-tecnico](http://www.zecspa.com/it/supporto-tecnico)).

*The option to use different materials for the hoses inner core, makes them suitable for several applications, handling also aggressive oils, polyols and emulsions. (See chemical compatibility chart available on: [www.zecspa.com/en/technical-support](http://www.zecspa.com/en/technical-support)).*



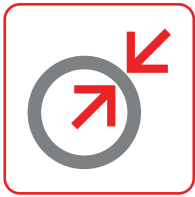

## **Compattezza e ridotta espansione volumetrica** **Compactness and reduced volumetric expansion**

I tubi termoplastici possono avere un diametro esterno molto ridotto, a parità di pressione di esercizio, rispetto ai tradizionali tubi in gomma. Inoltre, grazie alla loro struttura, assicurano una minor espansione volumetrica a parità di pressione.

*Thermoplastic hoses can have a very small outer diameter, at same working pressure, compared to traditional rubber hoses. Moreover they ensure a lower volumetric expansion, at same pressure rate.*

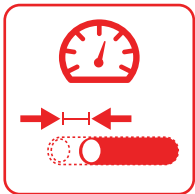

## **Minori perdite di carico ed allungamento in pressione** **Lower pressure drops and elongation under pressure**

La superficie liscia e compatta del tubo interno riduce al minimo l'attrito del fluido, così come possibili turbolenze e surriscaldamenti. ZEC prevede sulla propria gamma una percentuale massima di allungamento di +/- 1,5% (la metà rispetto ai tubi tradizionali).

*The smooth and compact inner core tubing surface, reduces fluid friction to a minimum, avoiding turbulences and overheatings. ZEC standard maximum elongation is +/-1,5% (50% of traditional rubber hoses).*

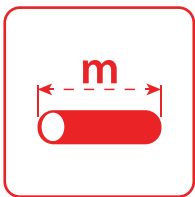

## **Pezzature lunghe** **Long lengths**

Per alcune linee di prodotto, i tubi termoplastici possono essere prodotti in lunghezze continue fino ad oltre 1000 metri, in funzione del diametro.

*For some product series, thermoplastic hoses can be manufactured in continuous lengths up to over 1.000 meters (over 3000ft), depending on size.*



## **Multitubi paralleli e soluzioni ombelicali** **Multiple hoses in parallel and umbilical solutions**

È possibile accoppiare fino a 6 tubi in composizione parallela, generando una soluzione con ingombri limitati. Inoltre ZEC è in grado di fornire soluzioni ombelicali, se necessario includendo anche cavi elettrici.

*ZEC offer multiple parallel solutions up to 6 hoses, reducing the overall dimensions. ZEC is also able to offer umbilical solutions, including also electrical cables, if required.*

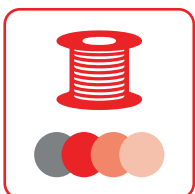

## **Flessibilità su personalizzazione ed imballi** **Flexibility on customization and packaging**

La soluzione termoplastica ZEC si presta alle personalizzazioni, con possibilità di un'ampia gamma di colori, ma anche lunghezze personalizzate e bobine per pezzature lunghe.

*ZEC thermoplastic solutions are easily customizable, offering a huge variety of colours, customized lengths and reels for long lengths.*



## **La soluzione idonea per gas** **Appropriate solution for gas handling**

Grazie all'uso di specifici materiali, il livello di permeabilità dei tubi termoplastici è di gran lunga inferiore a quello dei tradizionali tubi in gomma. ZEC dispone di uno specifico banco prova per test con gas inerte fino a 500 bar.

*The use of specific materials limits the permeability level of thermoplastic hoses compared to that of traditional rubber hoses. ZEC has a specific test bench for tests with inert gas up to 500 bar.*

## APPLICAZIONI

I tubi termoplastici ZEC per il settore industriale ricoprono una vasta gamma di applicazioni.

### MULTIUSO ARIA/ACQUA/OLIO / GENERAL PURPOSE AIR/WATER/OIL



- Applicazioni industriali generali / *General Industry*

TUBI / HOSES

OL5FLPU FLEX-FLOW

### VERNICIATURA STANDARD / STANDARD PAINT

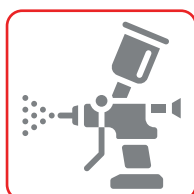

- Verniciatura bassa pressione / *Paint spray low pressure*
- Vernici base / *Paint spray standard*

TUBI / HOSES

VE5  
VE7  
VE7M  
VE8

### VERNICIATURA ANTISTATICA / ANTISTATIC PAINT

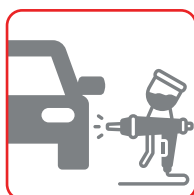

- Verniciatura antistatica / *Paint spray antistatic*

TUBI / HOSES

AS7	MT1-PA
AS8	MT2
MT1	MT2Y
MT1E	MTK

### INIEZIONE DI POLIURETANO ED APPLICAZIONE STUCCO / POLYURETHANE AND GROUTING INJECTION

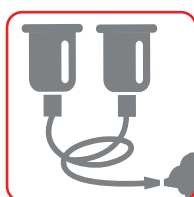

- Sistemi di iniezione poliuretano / *Polyurethane Injection*

TUBI / HOSES

VE8M	MTKM
MT2	VE5+PU
MT2Y	MT1+PA
MTK	

### RIFORMIMENTO E RICARICA CNG / CNG DISPENSING



- Stazioni di rifornimento di Gas Naturale / *CNG Station*

TUBI / HOSES

CNG

### STAZIONI GPL / LPG STATION

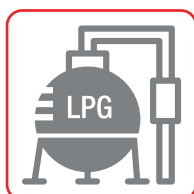

- Stazioni di rifornimento e ricarica GPL / *LPG Station*

TUBI / HOSES

GAS5 CONDUCTIVE

## APPLICATIONS

ZEC thermoplastic hoses for general industry cover a wide range of applications.

### ARIA RESPIRABILE / BREATHING AIR



- Dispositivi ad ossigeno / *Oxygen Systems*
- Apparecchiature per la respirazione subacquea / *SCUBA Systems*

#### TUBI / HOSES

AT7  
AT8  
AT8S  
AT8S-FEP

MTHAT1  
MTHAT2

### ALTA TEMPERATURA +130°C / HIGH TEMPERATURE +130°C

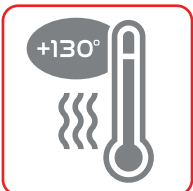

- Conduzione di olii idraulici / *Conduction of hydraulic oils*
- Conduzione di sostanze chimiche corrosive / *Conduction of corrosive chemicals agents*
- Industria alimentare / *Food Industry*

#### TUBI / HOSES

MT1HT-PTFE

### ALTA TEMPERATURA +260°C / HIGH TEMPERATURE +260°C

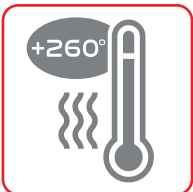

- Conduzione di vernici, olii e vapore / *Conduction of oils and steam*
- Industria alimentare / *Food Industry*
- Applicazioni autoestinguenti antiscintilla / *Self-extinguishing and spark proof applications*

#### TUBI / HOSES

PTFEIP  
PTFEIM  
PTFEIG  
PTFEI2T

PTFEIC  
TICI

### GESTIONE GAS E FLUIDI / GAS AND FLUIDS HANDLING



- Gestione e trasporto gas vari / *Gas Handling*

#### TUBI / HOSES

MTK-CO  
HOG  
CO<sub>2</sub> SYSTEM

### SOLUZIONI CON DETERGENTI E SOLVENTI / SOLUTIONS WITH DETERGENTS AND SOLVENTS



- Soluzioni con detersivi / *Solutions with detergents*
- Solventi / *Solvents*
- Solventi aggressivi / *Aggressive fluids*

#### TUBI / HOSES

VE5P-PA  
VE7  
AS7  
VE7M  
VE8  
AS8

MT1  
MT1E  
MT1-PA

## PANORAMICA TUBI

SOLUZIONI PER VERNICI, SOLVENTI, INIEZIONE / SOLUTIONS FOR PAINT SPRAY, SOLVENTS, INJECTION

















VE5	P.28	VE5P-PA	P.29	VE7	P.30
					
<p>APPLICAZIONI / APPLICATIONS</p> 		<p>APPLICAZIONI / APPLICATIONS</p> 		<p>APPLICAZIONI / APPLICATIONS</p>  	
AS7	P.31	VE7M	P.32	VE8	P.33
					
<p>APPLICAZIONI / APPLICATIONS</p>  		<p>APPLICAZIONI / APPLICATIONS</p>  		<p>APPLICAZIONI / APPLICATIONS</p>  	
AS8	P.34	VE8M	P.35	MT1	P.36
					
<p>APPLICAZIONI / APPLICATIONS</p>  		<p>APPLICAZIONI / APPLICATIONS</p> 		<p>APPLICAZIONI / APPLICATIONS</p>  	
MT1E	P.37	MT1-PA	P.38	MT2	P.39
					
<p>APPLICAZIONI / APPLICATIONS</p>  		<p>APPLICAZIONI / APPLICATIONS</p>  		<p>APPLICAZIONI / APPLICATIONS</p>  	

HOSES OVERVIEW

<b>MT2Y</b>	<b>P.40</b>	<b>MTK</b>	<b>P.41</b>	<b>MTKM</b>	<b>P.42</b>
					
<b>APPLICAZIONI / APPLICATIONS</b>		<b>APPLICAZIONI / APPLICATIONS</b>		<b>APPLICAZIONI / APPLICATIONS</b>	
 		 			
<b>VE5+PU</b>	<b>P.43</b>	<b>MT1+PA</b>	<b>P.44</b>		
					
<b>APPLICAZIONI / APPLICATIONS</b>		<b>APPLICAZIONI / APPLICATIONS</b>			
					

## PANORAMICA TUBI

SOLUZIONI PER LA GESTIONE DI GAS INDUSTRIALI / SOLUTIONS FOR GAS HANDLING

<b>GAS5 CONDUCTIVE</b>	<b>P.48</b>	<b>CNG</b>	<b>P.49</b>	<b>HOG</b>	<b>P.50</b>
					
<p>APPLICAZIONI / APPLICATIONS</p> 		<p>APPLICAZIONI / APPLICATIONS</p> 		<p>APPLICAZIONI / APPLICATIONS</p> 	
<b>AT7</b>	<b>P.51</b>	<b>AT8</b>	<b>P.52</b>	<b>AT8S</b>	<b>P.53</b>
					
<p>APPLICAZIONI / APPLICATIONS</p> 		<p>APPLICAZIONI / APPLICATIONS</p> 		<p>APPLICAZIONI / APPLICATIONS</p> 	
<b>AT8S-FEP</b>	<b>P.54</b>	<b>MTHAT1</b>	<b>P.55</b>	<b>MTHAT2</b>	<b>P.56</b>
					
<p>APPLICAZIONI / APPLICATIONS</p> 		<p>APPLICAZIONI / APPLICATIONS</p> 		<p>APPLICAZIONI / APPLICATIONS</p> 	
<b>MTK-CO</b>	<b>P.57</b>	<b>CO<sub>2</sub> SYSTEM</b>	<b>P.58</b>	<b>OL5FLPU FLEX-FLOW</b>	<b>P.59</b>
					
<p>APPLICAZIONI / APPLICATIONS</p> 		<p>APPLICAZIONI / APPLICATIONS</p> 		<p>APPLICAZIONI / APPLICATIONS</p> 	

## HOSES OVERVIEW

SOLUZIONI PER APPLICAZIONI AD ALTA TEMPERATURA / SOLUTIONS FOR HIGH TEMPERATURE APPLICATIONS

<b>MT1HT-PTFE</b>	<b>P.62</b>	<b>PTFEIP</b>	<b>P.63</b>	<b>PTFEIM</b>	<b>P.64</b>
					
<p>APPLICAZIONI / APPLICATIONS</p> 		<p>APPLICAZIONI / APPLICATIONS</p> 		<p>APPLICAZIONI / APPLICATIONS</p> 	
<b>PTFEIG</b>	<b>P.65</b>	<b>PTFEI2T</b>	<b>P.66</b>	<b>PTFEIC</b>	<b>P.67</b>
					
<p>APPLICAZIONI / APPLICATIONS</p> 		<p>APPLICAZIONI / APPLICATIONS</p> 		<p>APPLICAZIONI / APPLICATIONS</p> 	
<b>TICI</b>	<b>P.68</b>				
					
<p>APPLICAZIONI / APPLICATIONS</p> 					

## TABELLA DI SELEZIONE

			PRESSIONE / PRESSURE (BAR)									
			DN2	DN3	DN4	DN5	DN6	DN8	DN10	DN12	DN16	DN19
RINFORZO REINFORCEMENT	SERIE	DESCRIZIONE	1/12"	1/8"	5/32"	3/16"	1/4"	5/16"	3/8"	1/2"	5/8"	3/4"
TESSILE TEXTILE	OL5FLPU	FLEX-FLOW - MULTIUSO ARIA/ACQUA/OLIO					25		25	20	20	20
	VE5	VERNICIATURA BASSA PRESSIONE		200/267	200/267	200/267	145/193	120/160	115/153	80/107		
	VE5P-PA	85BAR SERIE ISOBARICA - SOLVENTI AGGRESSIVI				85/115	85/115	85/115	85/115	85/115		
	VE7	VERNICI E SOLVENTI - BASE		230/307		210/280	200/267	190/253	175/233	140/187	105/140	90/120
	AS7	VERNICI E SOLVENTI - CONDUTTIVO				250/333	228/304	190/253	228/304	140/187	105/140	90/120
	VE7M	250 SERIE ISOBARICA - VERNICI E SOLVENTI				250/333	250/333	250/333	250/333	210/280		
	VE8	VERNICI E SOLVENTI - HP E LEGGEREZZA		420/560		350/467	350/467	325/433	280/373	245/327	195/260	165/220
	AS8	VERNICI E SOLVENTI - HP E CONDUTTIVO				350/467	350/467	325/433	280/373	245/327		
	VE8M	INIEZIONE - HP E LEGGEREZZA			700	700	700		350/700	350		345
	GAS5 COND	STAZIONI GPL - CONDUTTIVO								35		35
	CNG	RIFORNIMENTO / RICARICA CNG - CONDUTTIVO					345	345	345	345		345
	HOG	INIEZIONE - ARIA/ACQUA/SOLVENTI				345	345/700/1000		345/689	345/689	345	345
	AT7	ARIA RESPIRABILE		230	250	210	200	190	175	140	105	90
	AT8	ARIA RESPIRABILE				350	350		280	245		165
	AT8S	ARIA RESPIRABILE				413	413		413	413		
AT8S-FEP	ARIA RESPIRABILE				425							
ACCIAIO WIRE	MT1	VERNICI E SOLVENTI BASE - CONDUTTIVO		375/500		350/467	300/400	240/320	225/300	190/254	150/200	130/174
	MT1E	VERNICI E SOLVENTI BASE - CONDUTTIVO				467	400	320	300	254		
	MT1-PA	VERNICI E SOLVENTI - CONDUTTIVO - PROTEZ. ESTERNA		375/500		350/467	300/400	240/320	225/300	190/254	150/200	130/174
	MT1HT-PTFE	ALTA TEMPERATURA (+130°C) - CONDUTTIVO		375		350	300	240	225	190	150	130
	MT2	VERNICI/INIEZIONE - CONDUTTIVO					400/534	350/467	330/440	275/367	250/334	215/287
	MT2Y	VERNICI/INIEZIONE - ISOBARICO - ALTA PRESSIONE					450/600		450/600			
	MTHAT1	ARIA RESPIRABILE / O2 - CONDUTTIVO					300		225	190		130
	MTHAT2	ARIA RESPIRABILE / O2 - HP - CONDUTTIVO					400		330	275		215
	PTFEIP	ALTA TEMPERATURA (+260°C) - SPESSORE MINIMO (R14)				200	175	150	135	120	100	90
	PTFEIM	ALTA TEMPERATURA (+260°C) - SPESSORE MEDIO		275		200	175	150	135	120	100	90
	PTFEIG	ALTA TEMPERATURA (+260°C) - SPESSORE GRANDE		275		200	175	150	135	120	100	90
	PTFEI2T	ALTA TEMPERATURA (+260°C) - DOPPIA TRECCIA				365	365	300	285	250	235	200
	PTFEIC	ALTA TEMPERATURA (+260°C) - CORRUGATO							120	110	80	70
TICI	ALTA TEMPERATURA (+600°C) - CORRUGATO* * DISPONIBILE FINO A 8" / AVAILABLE UP TO 8" SIZE							100	75	65	58	
IBRIDO HYBRID	MTK	VERNICI / INIEZIONE - CONDUTTIVO				500/666	700/933	500/666	425/566	375/500	250/333	225/300
	MTK-CO	GESTIONE GAS/FLUIDI - NAVALE/OFFSHORE							425		375	
	MTKM	INIEZIONE HP					800		700	700	350	325
	CO <sub>2</sub> SYSTEM	ANTINCENDIO - NAVALE				210	200/300	190/240	225	140/190		
SPECIALE SPECIAL	VE5+PU	SOLUZIONE BINATA ARIA / VERNICE				200						
	MT1+PA	SOLUZIONE BINATA - ARIA / STUCCO								190		130



## HOSE SELECTION TABLE

				ANIMA INTERNA INNER CORE	RIVESTIMENTO COVER	STANDARD	ALTRE SPECIFICHE OTHER SPECIFICATIONS	PAGINA PAGE	DESCRIPTION	SERIE
DN25	DN32	DN38	DN50							
1"	1 1/4"	1" 1/2	2"							
				PU: WP	PU: WP		MSHA	59	FLEX-FLOW - GENERAL PURPOSE AIR/ WATER/OIL	OL5FLPU
				PA	PU: OP		NON PIN-PRICKED	28	PAINT SPRAY - LOW PRESSURE	VE5
				PA	PA		EXTERNAL CHEMICAL RES.	29	85 BAR ISOBARIC - AGGRESSIVE FLUIDS	VE5P-PA
70/93				PA	PU: OP	SAE100-R7		30	PAINT SPRAY / SOLVENTS - STANDARD	VE7
70/93				PA	PU: OP BLUE	SAE100-R7	PATENTED n° IT-1328746	31	PAINT SPRAY / SOLVENTS - CONDUCTIVE	AS7
				PA	PU: OP	SAE 100R18		32	PAINT SPRAY / SOLVENTS - 250BAR ISOBARIC	VE7M
145/193				PA	PU: OP	SAE 100R8		33	PAINT SPRAY / SOLVENTS - COMPACT/ HIGH P.	VE8
				PA	PU: OP BLUE	SAE 100R8	PATENTED n° IT-1328746	34	PAINT SPRAY / SOLVENTS - CONDUCTIVE/ HIGH P.	AS8
250	250			PA	PU: WP	SAE100-R8	T.A. DNV-GL - MSHA	35	INJECTION - LIGHT / VERY HIGH PRESSURE	VE8M
	35			PA - COND.	PU: WP		MSHA	48	LPG STATION - CONDUCTIVE	GAS5 COND
345				PA - COND.	PU: WP RED	SAE100-R8	ISO 15500-17, ISO 8031, MSHA	49	CNG DISPENSING - CONDUCTIVE	CNG
345				PA	PU: WP	SAE100-R8	T.A. DNV-GL - MSHA	50	INJECTION - AIR/WATER/SOLVENTS	HOG
70				HTR-FG	PU: WP	SAE100-R7	FDA 21 CFR, EU 10-2011	51	BREATHING AIR / FOOD	AT7
				HTR-FG	PU: WP	SAE100-R8	FDA 21 CFR, EU 10-2011	52	BREATHING AIR / FOOD	AT8
				HTR-FG	PU: WP	SAE100-R8	EU 10/2011, CGA G-7.1 2004 GRADE E, DNV-GL, MSHA	53	BREATHING AIR / FOOD	AT8S
				FEP	PU: WP	SAE100-R8	EU 10/2011, CGA G-7.1 2004 GRADE E, MSHA	54	BREATHING AIR / FOOD	AT8S-FEP
105/140	70/94			PA	PU: OP	SAE100-R1		36	PAINT SPRAY / SOLVENTS - CONDUCTIVE	MT1
				PE COMPOUND	PU: OP		STATIC APPLICATIONS ONLY	37	PAINT SPRAY / SOLVENTS - CONDUCTIVE	MT1E
105/140	70/94			PA	PA	SAE100-R1	EXTERNAL CHEMICAL RES.	38	PAINT SPRAY / SOLVENTS - CONDUCTIVE - NYLON COVER	MT1-PA
105	70			PTFE	PU: OP		-40°C A + 135°C	62	HIGH TEMPERATURE - CONDUCTIVE	MT1HT-PTFE
165/220				PA	PU: OP	SAE100-R2		39	PAINT SPRAY / INJECTION - CONDUCTIVE	MT2
				PA	PU: OP BLUE EU	SAE100-R2		40	PAINT SPRAY / INJECTION - ISOBARIC - HIGH PRESSURE	
				HTR-FG	PU: WP	SAE100-R1	FDA 21 CFR, EU 10/2011	55	BREATHING AIR / FOOD - CONDUCTIVE	MTHAT1
				HTR-FG	PU: WP	SAE100-R2	FDA 21 CFR, EU 10/2011	56	BREATHING AIR / FOOD - CONDUCTIVE	MTHAT2
65				PTFE	AISI304 BRAID		Reg. UE 1935/2004 E 10/2011 FDA 21 CFR 177.1550	63	HIGH TEMPERATURE (+260°C)- SMALL THICKNESS (R14)	PTFEIP
65				PTFE	AISI304 BRAID		Reg. UE 1935/2004 E 10/2011 FDA 21 CFR 177.1550	64	HIGH TEMPERATURE (+260°C) - MEDIUM THICKNESS	PTFEIM
65				PTFE	AISI304 BRAID		Reg. UE 1935/2004 E 10/2011 FDA 21 CFR 177.1550	65	HIGH TEMPERATURE (+260°C) - LARGE THICKNESS	PTFEIG
150				PTFE	AISI304 BRAID		Reg. UE 1935/2004 E 10/2011 FDA 21 CFR 177.1550	66	HIGH TEMPERATURE (+260°C) - DOUBLE BRAID	PTFEI2T
50	45	40	36	PTFE	AISI304 BRAID		Reg. UE 1935/2004 E 10/2011 FDA 21 CFR 177.1550	67	HIGH TEMPERATURE (+260°C) - CORRUGATED	PTFEIC
55	50	40	30	AISI 321	AISI304 BRAID		UNI EN ISO 10380-2012	68	HIGH TEMPERATURE (+600°C) - CORRUGATED	TICI
200/266				PA	PU: WP		MSHA, T.A. DNV-GL	41	PAINT SPRAY / INJECTION - CONDUCTIVE	MTK
				PA-COND	PU: AUT		CONDUCTIVE - SELF EXTINGUISHING	57	GAS / FLUIDS HANDLING - MARINE/ OFFSHORE	MTKCO
325	275			PA	PU: WP		MSHA, T.A. DNV-GL	42	HP INJECTION	MTKM
				HTR	PU: WP	SAE 100-R1/R7	T.A. LR & DNV TAP00002C3, MSHA	58	FIRE SUPPRESSION - MARINE	CO <sub>2</sub> SYSTEM
				PA	PU: OP			43	TWIN SOLUTION AIR / ISOCYANATE	VE5+PU
				PA	PU: OP			44	TWIN SOLUTION AIR / GROUTING	MT1+PA

LEGENDA - MATERIALI: PU = POLIURETANO OP = OIL PROOF WP = WATER PROOF HTR = POLIESTERE PA = POLIAMMIDE

## CODIFICA TUBI E OPZIONI / HOSES AND OPTIONS CODING

Il codice identificativo di ciascun tubo termoplastico è composto da diversi elementi, ognuno dei quali fa riferimento ad una specifica caratteristica. Riportiamo di seguito un esempio di come è composto il codice di un tubo.



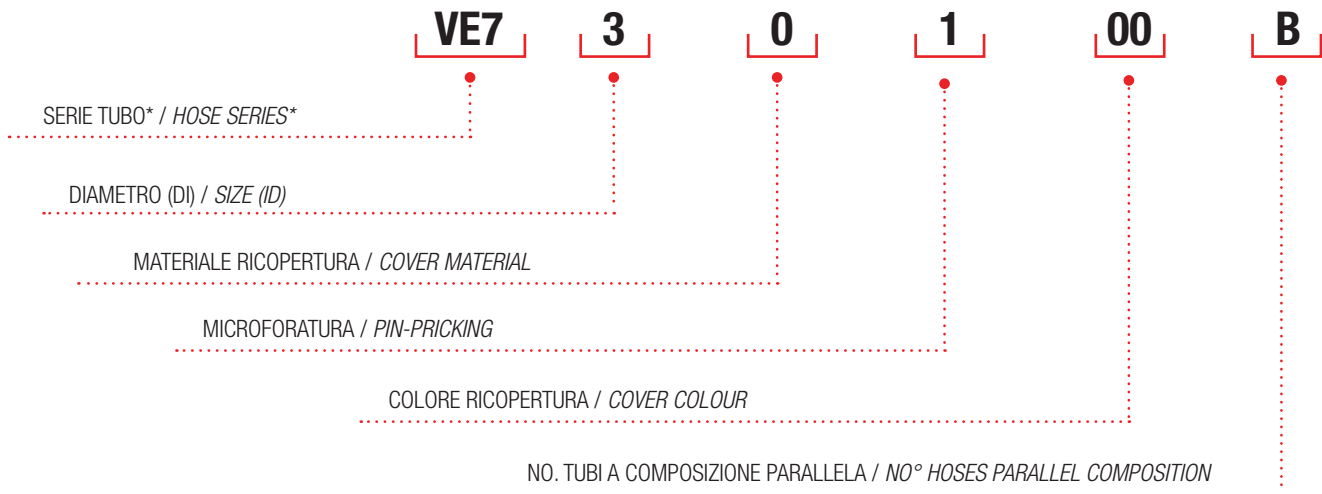













The identification code of each thermoplastic hose is composed of several elements, each of which refers to a specific feature. Below is an example of how a hose code is composed.

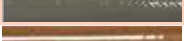

\* La SERIE TUBO specifica generalmente la tipologia di materiale utilizzato per l'anima interna e di conseguenza la compatibilità chimica del tubo. Per verificare la resistenza chimica a fluidi specifici vi invitiamo a consultare la relativa tabella sul sito: [www.zecspa.com/it/supporto-tecnico](http://www.zecspa.com/it/supporto-tecnico).

\* HOSE SERIES normally specifies inner core material type and so the chemical compatibility of the hose. To verify chemical resistance with specific fluids you are invited to check the on-line chart at: [www.zecspa.com/en/technical-support](http://www.zecspa.com/en/technical-support).

TABELLA COLORI TUBI ALTA PRESSIONE / HIGH PRESSURE HOSES COLOURS TABLE

COLORE / COLOUR	CODICE / CODE	IMMAGINE / PICTURE	SIMILE A / SIMILAR TO
Nero / Black	00		RAL 9005
Arancio / Orange	01		RAL 2004
Azzurro / Light Blue	02		RAL 5015
Blu EU / Blue EU	03		RAL 5002
Giallo Zinco / Zinc Yellow	04		RAL 1018
Rosso / Red	05		RAL 3028
Argento / Silver	07		RAL 9023
Verde / Green	09		RAL 6032
Bianco / White	10		RAL 9003
Trasparente / Transparent	11		-
Grigio RAL 7046 / Grey RAL 7046	12		RAL 7046
Bronzo / Bronze	13		-
Giallo chiaro / Light Yellow	14		RAL 1016
Magenta / Magenta	18		RAL 4010
Verde PANTONE® 382 / Green PANTONE® 382	22		PANTONE® 382
Giallo segnale / Signal Yellow	23		RAL 1003
Blu PANTONE® 281 / Blue PANTONE® 281	24		PANTONE® 281 - RAL 5003

## CODICI IDENTIFICATIVI TUBI ALTA PRESSIONE / HIGH PRESSURE HOSE CODES DEFINITION

DIAMETRO (DI) / SIZE (ID)	MATERIALE RICOPERTURA / COVER MATERIAL	MICROFORATURA / PINPRICKING	COLORE ESTERNO / EXTERNAL COLOUR	MULTITUBI / MULTI-HOSE
1 = 1/8"	0 = PU POLIESTERE / OIL PROOF PU	0 = NO / NO	00 = NERO / BLACK	B = 2 TUBI / HOSES
2 = 3/16"	1 = POLIESTERE / TPEE	1 = SI / YES	01 = ARANCIO / ORANGE	T = 3 TUBI / HOSES
3 = 1/4"				Q = 4 TUBI / HOSES
4 = 5/16"	3 = POLIAMMIDE / POLYAMIDE			C = 5 TUBI / HOSES
5 = 3/8"	7 = PU POLIESTERE / WATER PROOF PU			S = 6 TUBI / HOSES
6 = 1/2"	8 = PU AUTOESTINGUENTE / SELF-EXTINGUISHING PU			
7 = 5/8"	12 = PU OPACO / MATT WATER PROOF			
8 = 3/4"				
9 = 1"				
10 = 1" 1/4				
12 = 1" 1/2				

## OPZIONI / OPTIONS

### 1) Materiali anima interna disponibili:

- Poliammide
- Poliestere Alimentare (AT7, AT8, AT8S, CO2 system, MTHAT1, MTHAT2)

### 2) Colori ricopertura (vedi tabella colori pag. 24)

### 3) Lunghezze:

- standard tra 50 e 200 m a seconda dei diametri / tipologie di tubo
- possibilità di richiedere lunghezze specifiche (o multipli)

### 4) Marcatura:

- standard ZEC (bianco o giallo)
- personalizzabile in caso di esigenze specifiche

### 5) Imballi:

- rotoli avvolti in film plastico
- opzioni bobine (cartone e legno) a seconda delle esigenze



### 6) Tracciabilità:

Ogni singolo rotolo ha una sua carta di identità riportata in etichetta, che rispecchia il numero di lotto impresso sul tubo. Da questi dati è possibile risalire a tutti i processi di lavorazione e fino alle materie prime utilizzate.

### 7) Test:

Su ogni lotto di prodotto finito certificato di collaudo 3.1 (SAE J343 / ISO 1402).

Altri test periodici o a richiesta:

- test ad impulsi SAE J343 / ISO 6803
- test di abrasione UNI ISO 6945 / DIN 20040

### 1) Inner core available materials:

- Polyamide
- Polyester for food contact (AT7, AT8, AT8S, CO2 system, MTHAT1, MTHAT2)

### 2) Cover colours (see colour table p. 24)

### 3) Lengths:

- standard from 50 to 200 m depending on hose diameters / types
- possibility to request specific (or multiple) lengths

### 4) Marking:

- ZEC standard (white or yellow)
- customizable in case of specific requirements

### 5) Packing:

- coils wrapped in plastic film
- reel options (cardboard and wood), according to specific requirements



### 6) Traceability:

Each single coil has its own identity card on the label, which reflects the lot number printed on the hose. From these data it is possible to trace all the manufacturing processes, up to the raw materials used.

### 7) Tests:

To each finished product batch test certificate 3.1 (SAE J343 / ISO 1402).

Other periodic tests or tests on request:

- impulse test SAE J343 / ISO 6803
- abrasion test UNI ISO 6945 / DIN 20040

## Le soluzioni ZEC per il passaggio di vernici, solventi ed iniezione

ZEC offre una gamma di tubi termoplastici microforati, progettati per la conduzione a media e ad alta pressione di polioli, solventi e vernici.

### CARATTERISTICHE TECNICHE

- Leggerezza
- Elevata resistenza all'abrasione
- Eccellente resistenza chimica

### APPLICAZIONI



VERNICIATURA STANDARD



VERNICIATURA ANTISTATICA

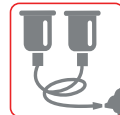

INIEZIONE DI POLIURETANO E APPLICAZIONE STUCCO



SOLUZIONI CON DETERGENTI E SOLVENTI

### CERTIFICAZIONI

Tutti i tubi ZEC sono prodotti in conformità al **Regolamento Europeo CE 1907/2006 "REACH"** e alla **Direttiva Europea UE 65/2011 "RoHS"**.

### QUALITÀ

Il sistema di qualità certificato **ISO 9001:2015 ZEC** assicura un controllo continuo e costante del processo produttivo, garantendo il rispetto delle buone pratiche di fabbricazione.

## ZEC Solutions for Paint Spray, Solvents and Injection

ZEC offers a range of thermoplastic micro perforated hoses designed for medium and high pressure conduction of polyols, solvents and paints.

### TECHNICAL FEATURES

- *Lightweight*
- *High abrasion resistance*
- *Excellent chemical resistance*

### APPLICATIONS



STANDARD PAINT



ANTISTATIC PAINT



POLYURETHANE AND GROUTING INJECTION



SOLUTIONS WITH DETERGENTS AND SOLVENTS

### CERTIFICATIONS

All ZEC hoses are manufactured in conformity to **European Regulation EU 1907/2006 "REACH"** and **European Directive EU 2011/65 "RoHS"**.

### QUALITY

The certified **ISO 9001:2015 ZEC** quality system ensures a continuous and constant control of the production process, guaranteeing compliance with Good Manufacturing Practices.

*Paint Spray / Solvents / Injection*



## VE5 OIL-PROOF COVER



### Caratteristiche principali

- Pressione da 80 a 200 bar - rapporto sicurezza 1:4
- Soluzione compatta ed estremamente flessibile
- Conduzione di vernici e polioli a media pressione

### Main Features

- Pressure from 80 to 200 bar - safety ratio 1:4
- Compact and extremely flexible solution
- Medium pressure solution for paints and polyols

### Caratteristiche tecniche

#### • Caratteristiche tecnico-costruttive:

Anima interna in poliammide, rinforzo con singola treccia in fibra poliestere e ricopertura esterna in poliammide a richiesta micro perforato per passaggio di aria e gas compatibili. Queste tubazioni non sono in grado di disperdere le cariche elettrostatiche che possono accumularsi nel caso di passaggio di fluidi non conduttivi.

#### • Temperature di utilizzo:

Da -40°C a +100°C Da -40°F a +212°F

Per aria, acqua e fluidi a base acquosa la temperatura massima di esercizio è + 70°C (+158°F)

#### • Pressioni d'esercizio:

Rapporto di sicurezza 1:4 per pressione DINAMICA

Rapporto di sicurezza 1:3 per pressione STATICA

#### • Valore max. di vuoto:

0,93 bar; 700 mm Hg

### Technical Features

#### • Technical-constructive features:

Inner core in polyamide, reinforcement with one single polyester fiber braid and external covering in polyamide, micro perforated on request for the conduction of air and compatible gases. These hoses are not able to dissipate electrostatic charges that may build up in case non-conductive fluids are conveyed.

#### • Working temperatures:

from -40°C to +100°C from -40°F to +212°F.

Max. working temperature of air, water and water-based fluids is + 70°C (+158°F).

#### • Working pressure:

Safety ratio 1:4 for DYNAMIC pressure

Safety ratio 1:3 for STATIC pressure

#### • Vacuum rating:

0.93 bar; 700 mm Hg

### Scheda tecnica - Data Sheet



CODE	inch	-dash	mm	DN	inch	mm	bar	psi	bar	psi	mm	inch	g/m	lbs/ft	FERRULE CODE
VE510000	1/8"	-2	3.5	3	0.295	7.5	200	2900	267	3872	25	0.98	36	0.024	BP180L5
VE570000	5/32"	-2.5	4.0	4	0.315	8.0	200	2900	267	3872	30	1.18	41	0.028	BP480L5
VE520000	3/16"	-3	4.8	5	0.362	9.2	200	2900	267	3872	30	1.18	56	0.038	BP3160L5
VE530000	1/4"	-4	6.4	6	0.425	10.8	145	2103	193	2799	45	1.77	65	0.044	BP140L5
VE540000	5/16"	-5	8.0	8	0.512	13.0	120	1740	160	2320	50	1.97	94	0.063	BP5160L5
VE550000	3/8"	-6	9.7	10	0.583	14.8	115	1667	153	2219	55	2.17	115	0.077	BP380L5
VE560000	1/2"	-8	13.0	12	0.736	18.7	80	1160	107	1552	90	3.54	157	0.106	BP120L5

## VE5P-PA PA COVER

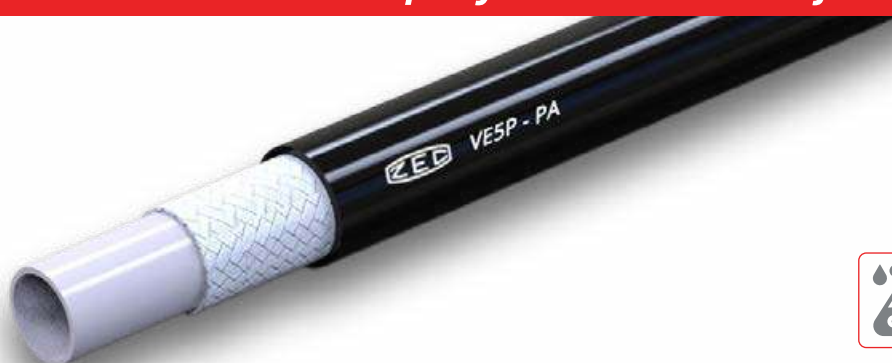

### Caratteristiche principali

- Pressione costante a 85 bar - rapporto sicurezza 1:4
- Elevata resistenza chimica anche esterna
- Conduzione di polioli e vernici a bassa pressione

### Main Features

- Constant pressure at 85 bar - safety ratio 1:4
- Extreme chemical resistance, outside too
- Medium pressure solution for polyols and paints

### Caratteristiche tecniche

#### • Caratteristiche tecnico-costruttive:

Anima interna in poliammide, rinforzo con singola treccia in fibra poliestere e ricopertura esterna in poliammide a richiesta micro perforata per passaggio di aria e gas compatibili. Queste tubazioni non sono in grado di disperdere le cariche elettrostatiche che possono accumularsi nel caso di passaggio di fluidi non conduttivi.

#### • Temperature di utilizzo:

Da -40°C a +100°C Da -40°F a +212°F

Per aria, acqua e fluidi a base acquosa la temperatura massima di esercizio è + 70°C (+158°F).

#### • Pressioni d'esercizio:

Rapporto di sicurezza 1:4 per pressione DINAMICA

Rapporto di sicurezza 1:3 per pressione STATICA

#### • Valore max. di vuoto:

0,93 bar; 700 mm Hg

### Technical Features

#### • Technical-constructive features:

Inner core in polyamide, reinforcement with one single polyester fiber braid and external covering in polyamide micro perforated version on request for the conduction of air and compatible gases. These hoses are not able to dissipate electrostatic charges that may build up in case non-conductive fluids are conveyed.

#### • Working temperatures:

from -40°C to +100°C from -40°F to +212°F.

Max. working temperature of air, water and water-based fluids is + 70°C (+158°F).

#### • Working pressure:

Safety ratio 1:4 for DYNAMIC pressure

Safety ratio 1:4 for STATIC pressure

#### • Vacuum rating:

0.93 bar; 700 mm Hg

### Scheda tecnica - Data Sheet



CODE	inch	-dash	mm	DN	inch	mm	bar	psi	bar	psi	mm	inch	g/m	lbs/ft	FERRULE CODE
VE5P23000	3/16"	-3	4.8	5	0.315	8.0	85	1250	115	1668	50	1.97	36	0.024	BP3160L5
VE5P33000	1/4"	-4	6.4	6	0.386	9.8	85	1250	115	1668	60	2.36	47	0.032	BP140L5
VE5P43000	5/16"	-5	8.0	8	0.386	12.2	85	1250	115	1668	75	2.95	68	0.046	BP5160L5
VE5P53000	3/8"	-6	9.7	10	0.539	13.7	85	1250	115	1668	90	3.54	76	0.051	BP380L5
VE5P63000	1/2"	-8	13.0	12	0.696	17.7	85	1250	115	1668	120	4.72	121	0.081	BP120L5

## VE7 OIL-PROOF COVER



### Caratteristiche principali

- Pressione da 70 a 230 bar - rapporto di sicurezza 1:4
- Pressione da 93 a 307 bar - rapporto di sicurezza 1:3
- Per la conduzione a media pressione di polioli, solventi, vernici e gas compatibili

### Main Features

- Pressure from 70 to 230 bar - safety ratio 1:4
- Pressure from 93 to 307 bar - safety ratio 1:3
- Medium pressure solution for polyols, solvents, paints and compatible gases

### Caratteristiche tecniche

- **Caratteristiche tecnico-costruttive:**  
Anima interna in poliammide, rinforzo in fibra poliestere e rivestimento esterno in poliuretano antiabrasione microperforato per passaggio aria e gas compatibili.  
Queste tubazioni non sono in grado di disperdere le cariche elettrostatiche che possono accumularsi nel caso di passaggio di fluidi non conduttivi.
- **Temperature di utilizzo:**  
Da -40°C a +100°C Da -40°F a +212°F  
Per aria, acqua e fluidi a base acquosa la temperatura massima di esercizio è +70°C (+158°F).
- **Pressioni d'esercizio:**  
Rapporto di sicurezza 1:4 per pressione DINAMICA (in conformità a norme SAE)  
Rapporto di sicurezza 1:3 per pressione STATICA
- **Valore max. di vuoto:**  
0,93 bar; 700 mm Hg
- **Specifiche:**  
Tubazioni conformi o superiori alle norme SAE J517 sez. SAE 100R7 - ISO 3949.

### Technical Features

- **Technical-constructive features:**  
Inner core in polyamide, polyester textile reinforcement and exterior covering in antiabrasion micro perforated polyurethane for the conduction of air and compatible gases. These hoses are not able to dissipate electrostatic charges that may build up in case non-conductive fluids are conveyed.
- **Working temperature:**  
from -40°C to +100°C from -40°F to +212°F.  
Max. working temperature of air, water and water-based fluids is +70°C (+158°F).
- **Working pressure:**  
Safety ratio 1:4 for DYNAMIC pressure (according to SAE norm)  
Safety ratio 1:3 for STATIC pressure
- **Vacuum rating:**  
0.93 bar; 700 mm Hg
- **Specifications:**  
Meet or exceed SAE J517 sec. 100R7 and ISO 3949 Standards.

### Scheda tecnica - Data Sheet



CODE	inch	-dash	mm	DN	inch	mm	bar	psi	bar	psi	mm	inch	g/m	lbs/ft	FERRULE CODE
VE710100	1/8"	-2	3.5	3	0.335	8.5	230	3335	307	4453	12	0.47	54	0.036	BP18R7
VE720100	3/16"	-3	4.8	5	0.394	10.0	210	3045	280	4061	30	1.18	68	0.046	BP316R7
VE730100	1/4"	-4	6.4	6	0.465	11.8	200	2900	267	3872	35	1.38	87	0.058	BP14R7
VE740100	5/16"	-5	8.0	8	0.563	14.3	190	2755	253	3669	45	1.77	126	0.085	BP516R7V
VE750100	3/8"	-6	9.7	10	0.630	16.0	175	2537	233	3379	55	2.17	146	0.098	BP38R7V
VE760100	1/2"	-8	13.0	12	0.799	20.3	140	2030	187	2712	75	2.95	214	0.144	BP12R7V
VE770100	5/8"	-10	16.0	16	0.925	23.5	105	1522	140	2030	120	4.72	258	0.173	BP58R7V
VE780100	3/4"	-12	19.2	19	1.043	26.5	90	1305	120	1740	145	5.71	301	0.202	BP34R7V
VE790100	1"	-16	25.6	25	1.322	33.6	70	1015	93	1349	200	7.87	369	0.248	BP1R7V



## AS7 ANTISTATIC

Brevetto  
N° IT-1328746  
Patent



### Caratteristiche principali

- Pressione da 70 a 250 bar - rapporto sicurezza 1:4
- Pressione da 93 a 333 bar - rapporto sicurezza 1:3
- Per la conduzione a media pressione di polioli, solventi, vernici e gas compatibili
- Resistenza elettrica minore di  $3 \times 10^4 \Omega/m$

### Main Features

- Pressure from 70 to 250 bar - safety ratio 1:4
- Pressure from 93 to 333 bar - safety ratio 1:3
- Medium pressure solution for polyols, solvents, paints and compatible gases
- Electrical resistance less than  $3 \times 10^4 \Omega/m$

### Caratteristiche tecniche

#### • Caratteristiche tecnico-costruttive:

Anima interna in poliammide, rinforzo con due trecce in fibra poliestere, ricopertura esterna in poliuretano antiabrasione microperforato per passaggio aria e gas compatibili.

La resistenza elettrica della tubazione risulta: minore di  $3 \times 10^4 \Omega/m$  secondo la norma ISO 8031.

#### • Temperature di utilizzo:

Da  $-40^\circ\text{C}$  a  $+100^\circ\text{C}$  Da  $-40^\circ\text{F}$  a  $+212^\circ\text{F}$

Per aria, acqua e fluidi a base acquosa la temperatura massima di esercizio è  $+70^\circ\text{C}$  ( $+158^\circ\text{F}$ ).

#### • Pressioni d'esercizio:

Rapporto di sicurezza 1:4 per pressione DINAMICA (in conformità alle norme SAE)

Rapporto di sicurezza 1:3 per pressione STATICA

#### • Valore max. di vuoto:

0,93 bar; 700 mm Hg

#### • Specifiche:

Tubazioni conformi o superiori alle norme SAE J517 sez. SAE 100R7 - ISO 3949.

### Technical Features

#### • Technical-constructive features:

Inner core in polyamide, polyester textile double braid reinforcement, external covering in antiabrasion micro perforated polyurethane for the conduction of air and compatible gases. The hose's electrical resistance is less than  $3 \times 10^4 \Omega/m$  in accordance with ISO 8031 Standard.

#### • Working temperature:

from  $-40^\circ\text{C}$  to  $+100^\circ\text{C}$  from  $-40^\circ\text{F}$  to  $+212^\circ\text{F}$ .

Max. working temperature of air, water and water-based fluids is  $+70^\circ\text{C}$  ( $+158^\circ\text{F}$ ).

#### • Working pressure:

Safety ratio 1:4 for DYNAMIC pressure (according to SAE norm)

Safety ratio 1:3 for STATIC pressure

#### • Vacuum rating:

0.93 bar; 700 mm Hg

#### • Specifications:

Hoses meet or exceed SAE J517 sect. SAE 100R7 – ISO 3949 Standards. Patent No.

### Scheda tecnica - Data Sheet



CODE	inch	-dash	mm	DN	inch	mm	bar	psi	bar	psi	mm	inch	g/m	lbs/ft	FERRULE CODE
AS720102	3/16"	-3	4.8	5	0.413	10.5	250	3625	333	4830	30	0.47	75	0.050	BP316R7
AS730102	1/4"	-4	6.4	6	0.500	12.7	228	3306	304	4409	40	1.18	102	0.068	BP14MT1
AS740102	5/16"	-5	8.0	8	0.563	14.3	190	2755	253	3669	55	1.38	126	0.084	BP516R7V
AS750102	3/8"	-6	9.7	10	0.681	17.3	228	3306	304	4409	60	1.77	179	0.120	BP380L7M
AS760102	1/2"	-8	13.0	12	0.799	20.3	140	2030	187	2712	75	2.17	214	0.144	BP12R7V
AS770102	5/8"	-10	16.0	16	0.925	23.5	105	1522	140	2030	120	2.95	258	0.173	BP58R7V
AS780102	3/4"	-12	19.2	19	1.043	26.5	90	1305	120	1740	145	4.72	301	0.202	BP34R7V
AS790102	1"	-16	25.6	25	1.322	33.6	70	1015	93	1349	200	5.71	369	0.248	BP1R7V

## VE7M OIL-PROOF COVER



### Caratteristiche principali

- Pressione da 210 a 250 bar - rapporto sicurezza 1:4
- Pressione da 280 a 333 bar - rapporto sicurezza 1:3
- Per la conduzione ad alta pressione di polioli, solventi, vernici e gas compatibili

### Main Features

- Pressure from 210 to 250 bar - safety ratio 1:4
- Pressure from 280 to 333 bar - safety ratio 1:3
- High pressure solution for polyols, solvents, paints and compatible gases

### Caratteristiche tecniche

- **Caratteristiche tecnico-costruttive:**  
Anima interna in poliammide, rinforzo con due trecce in fibra poliestere e rivestimento esterno in poliuretano antiabrasione, microperforato per passaggio aria e gas compatibili. Queste tubazioni non sono in grado di disperdere le cariche elettrostatiche che possono accumularsi nel caso di passaggio di fluidi non conduttivi.
- **Temperature di utilizzo:**  
Da -40°C a +100°C Da -40°F a +212°F  
Per aria, acqua e fluidi a base acquosa la temperatura massima di esercizio è +70°C (+158°F).
- **Pressioni d'esercizio:**  
Rapporto di sicurezza 1:4 per pressione DINAMICA (in conformità alle norme SAE)  
Rapporto di sicurezza 1:3 per pressione STATICA
- **Valore max. di vuoto:**  
0,93 bar; 700 mm Hg
- **Specifiche:**  
Tubazioni conformi o superiori alle norme SAE J517 sez. SAE 100R18 – ISO 3949.

### Technical Features

- **Technical-constructive features:**  
Inner core in polyamide, polyester textile double braid reinforcement and exterior covering in antiabrasion polyurethane, micro perforated for the conduction of air and compatible gases. These hoses are not able to dissipate electrostatic charges that may build up in case non-conductive fluids are conveyed.
- **Working temperature:**  
from -40°C to +100°C from -40°F to +212°F.  
Max. working temperature of air, water and water-based fluids is +70°C (+158°F).
- **Working pressure:**  
Safety ratio 1:4 for DYNAMIC pressure (according to SAE norm)  
Safety ratio 1:3 for STATIC pressure
- **Vacuum rating:**  
0.93 bar; 700 mm Hg
- **Specifications:**  
Hoses meet or exceed SAE J517 sect. SAE 100R18 – ISO 3949 Standards.

### Scheda tecnica - Data Sheet



CODE	inch	-dash	mm	DN	inch	mm	bar	psi	bar	psi	mm	inch	g/m	lbs/ft	FERRULE CODE
VE7M20100	3/16"	-3	4.8	5	0.413	10.5	250	3625	333	4830	30	1.18	77	0.052	BP316R7
VE7M30100	1/4"	-4	6.4	6	0.500	12.7	250	3625	333	4830	40	1.57	105	0.071	BP14MT1
VE7M40100	5/16"	-5	8.0	8	0.591	15.0	250	3625	333	4830	50	1.97	148	0.099	BP516R7V
VE7M50100	3/8"	-6	9.5	10	0.709	18.0	250	3625	333	4830	50	1.97	196	0.132	BP380L7M
VE7M60100	1/2"	-8	13.0	12	0.890	22.6	210	3045	280	4061	70	2.75	308	0.207	BP12R2TV

## VE8 OIL-PROOF COVER



### Caratteristiche principali

- Pressione da 145 a 420 bar - rapporto sicurezza 1:4
- Pressione da 193 a 560 bar - rapporto sicurezza 1:3
- Soluzione ultra compatta e leggera
- Per la conduzione ad alta pressione di polioli, solventi, vernici e gas compatibili

### Main Features

- Pressure from 145 to 420 bar - safety ratio 1:4
- Pressure from 193 to 560 bar - safety ratio 1:3
- Extremely compact and light solution
- High pressure solution for polyols, solvents, paints and compatible gases

### Caratteristiche tecniche

• **Caratteristiche tecnico-costruttive:**  
Anima interna in poliammide, rinforzo in fibre tessili ad alta tenacità e rivestimento esterno in poliuretano antiabrasione, microperforato per passaggio aria e gas compatibili. Queste tubazioni non sono in grado di disperdere le cariche elettrostatiche che possono accumularsi nel caso di passaggio di fluidi non conduttivi.

• **Temperature di utilizzo:**  
Da -40°C a +100°C Da -40°F a +212°F  
Per aria, acqua e fluidi a base acquosa la temperatura massima di esercizio è + 70°C (+158°F).

• **Pressioni d'esercizio:**  
Rapporto di sicurezza 1:4 per pressione DINAMICA (in conformità alle norme SAE)  
Rapporto di sicurezza 1:3 per pressione STATICA

• **Valore max. di vuoto:**  
0,93 bar; 700 mm Hg

• **Specifiche:**  
Tubazioni conformi o superiori alle norme SAE J517 sez. SAE 100R8 - ISO 3949.

### Technical Features

• **Technical-constructive features:**  
Inner core in polyamide, high toughness textile fiber and exterior covering in antiabrasion polyurethane, micro perforated for the conduction of air and compatible gases. These hoses are not able to dissipate electrostatic charges that may build up in case non-conductive fluids are conveyed.

• **Working temperatures:**  
from -40°C to +100°C from -40°F to +212°F.  
Max. working temperature of air, water and water-based fluids is + 70°C (+158°F).

• **Working pressure:**  
Safety ratio 1:4 for DYNAMIC pressure (according to SAE norm)  
Safety ratio 1:3 for STATIC pressure

• **Vacuum rating:**  
0.93 bar; 700 mm Hg

• **Specifications:**  
Hoses meet or exceed SAE J517 sect. SAE 100R8 – ISO 3949 Standards.

### Scheda tecnica - Data Sheet



CODE	inch	-dash	mm	DN	inch	mm	bar	psi	bar	psi	mm	inch	g/m	lbs/ft	FERRULE CODE
VE810100	1/8"	-2	3.5	3	0.280	7.1	420	6090	560	8122	30	1.18	31	0.021	BP180L5
VE820100	3/16"	-3	4.8	5	0.394	10.0	350	5075	467	6773	35	1.38	88	0.059	BP316R7
VE830100	1/4"	-4	6.4	6	0.465	11.8	350	5075	467	6773	50	1.97	83	0.056	BP14R7
VE840100 (**)	5/16"	-5	8.0	8	0.563	14.3	325	4712	433	6280	60	2.36	122	0.082	BP516R7V
VE850100	3/8"	-6	9.7	10	0.630	16.0	280	4060	373	5410	70	2.76	140	0.094	BP38R7V
VE860100	1/2"	-8	13.0	12	0.799	20.3	245	3552	327	4743	95	3.74	218	0.146	BP12R7V
VE870100	5/8"	-10	16.0	16	0.925	23.5	195	2827	260	3771	125	4.92	285	0.192	BP58R7V
VE880100	3/4"	-12	19.2	19	1.043	26.5	165	2392	220	3191	150	5.91	341	0.229	BP34R7V
VE890100	1"	-16	25.6	25	1.366	34.7	145	2100	193	2799	200	7.87	475	0.319	BP1R1TV

\*\* Tubazione non prevista dalla normativa SAE 100R8.

\*\* Hose not provided for by SAE 100R8 Standard.

## AS8 ANTISTATIC

Brevetto  
N° IT-1328746  
Patent



### Caratteristiche principali

- Pressione da 245 a 350 bar - rapporto sicurezza 1:4
- Pressione da 327 a 467 bar - rapporto sicurezza 1:3
- Per la conduzione ad alta pressione di polioli, solventi, vernici e gas compatibili
- Resistenza elettrica minore di  $3 \times 10^4 \Omega/m$

### Main Features

- Pressure from 245 to 350 bar - safety ratio 1:4
- Pressure from 327 to 467 bar - safety ratio 1:3
- High pressure solution for polyols, solvents, paints and compatible gases
- Electrical resistance less than  $3 \times 10^4 \Omega/m$

### Caratteristiche tecniche

- **Caratteristiche tecnico-costruttive:**  
Anima interna in poliammide, rinforzo con due trecce in fibra aramidica, ricopertura esterna in poliuretano antiabrasione microperforato per passaggio aria e gas compatibili.  
La resistenza elettrica della tubazione risulta: minore di  $3 \times 10^4 \Omega/m$  secondo la norma ISO 8031.
- **Temperature di utilizzo:**  
Da  $-40^\circ\text{C}$  a  $+100^\circ\text{C}$     Da  $-40^\circ\text{F}$  a  $+212^\circ\text{F}$   
Per aria, acqua e fluidi a base acquosa la temperatura massima di esercizio è  $+70^\circ\text{C}$  ( $+158^\circ\text{F}$ ).
- **Pressioni d'esercizio:**  
Rapporto di sicurezza 1:4 per pressione DINAMICA (in conformità alle norme SAE)  
Rapporto di sicurezza 1:3 per pressione STATICA
- **Valore max. di vuoto:**  
0,93 bar; 700 mm Hg
- **Specifiche:**  
Tubazioni conformi o superiori alle norme SAE J517 sez. SAE 100R8 - ISO 3949.

### Technical Features

- **Technical-constructive features:**  
Inner core in polyamide, reinforcement in two Aramid fiber braids, external covering in antiabrasion micro perforated polyurethane for the conduction of air and compatible gases.  
The hose's electrical resistance is less than  $3 \times 10^4 \Omega/m$  in accordance with ISO 8031 Standard.
- **Working temperatures:**  
from  $-40^\circ\text{C}$  to  $+100^\circ\text{C}$     from  $-40^\circ\text{F}$  to  $+212^\circ\text{F}$   
Max. working temperature of air, water and water-based fluids is  $+70^\circ\text{C}$  ( $+158^\circ\text{F}$ ).
- **Working pressure:**  
Safety ratio 1:4 for DYNAMIC pressure (according to SAE norm)  
Safety ratio 1:3 for STATIC pressure
- **Vacuum rating:**  
0.93 bar; 700 mm Hg
- **Specifications:**  
Hoses meet or exceed SAE J517 sect. SAE 100R8 – ISO 3949 Standards.

### Scheda tecnica - Data Sheet



CODE	inch	-dash	mm	DN	inch	mm	bar	psi	bar	psi	mm	inch	g/m	lbs/ft	FERRULE CODE
AS820102	3/16"	-3	4.8	5	0.394	10.0	350	5075	467	6773	35	1.38	88	0.059	BP316R7
AS830102	1/4"	-4	6.4	6	0.465	11.8	350	5075	467	6773	50	1.97	83	0.056	BP14R7
AS840102	5/16"	-5	8.0	8	0.563	14.3	325	4712	433	6280	60	2.36	122	0.082	BP516R7V
AS850102	3/8"	-6	9.7	10	0.630	16.0	280	4060	373	5410	70	2.76	168	0.113	BP38R7V
AS860102	1/2"	-8	13.0	12	0.799	20.3	245	3550	327	4743	95	3.74	218	0.146	BP12R7V

## VE8M WATERPROOF COVER



### Caratteristiche principali

- Pressione da 250 a 700 bar
- Normativa SAE J517-100R8, ISO 3949, DNV-GL
- Per la conduzione ad alta pressione di olii, polioli, solventi e gas compatibili in ambiente marino e offshore

### Main Features

- Pressure from 250 to 700 bar
- SAE J517-100R8, ISO 3949, DNV-GL standard
- High pressure solution for oils, polyols, solvents and compatible gases in marine and offshore environments

### Caratteristiche tecniche

• **Caratteristiche tecnico-costruttive:**  
Anima interna in poliammide, rinforzo in fibra aramidica e rivestimento esterno in poliuretano antiabrasione, stabilizzato ai raggi UV, resistente all'ozono, ai microorganismi ed all'idrolisi, adatto per applicazioni all'esterno in ambienti particolarmente umidi e salini, microforato per passaggio aria e gas compatibili.

• **Temperature di utilizzo:**  
Da -40°C a +100°C    Da -40°F a +212°F.  
Per aria, acqua e fluidi a base acquosa la temperatura massima di esercizio è +70°C (+158°F).

• **Pressioni d'esercizio:**  
Rapporto di sicurezza 1:4

• **Valore max. di vuoto:**  
0.93 bar; 700 mm Hg

• **Specifiche:**  
Tubazioni conformi o superiori alle norme SAE J517 - 100R8, ISO 3949, DNV-GL.

### Technical Features

• **Technical-constructive features:**  
Inner core in polyamide, reinforcement in aramid fibre, outside cover in abrasion resistant polyurethane, UV-stabilized, resistant to ozone, microorganisms and hydrolysis, suitable for outdoor applications in wet and saline environments, pinpricked for conduction of air and compatible gases.

• **Working temperatures:**  
From -40°C to +100°C    From -40°F to +212°F.  
Max. working temperature with air, water and water-based fluids is +70°C (+158°F).

• **Working pressure:**  
Safety ratio 1:4

• **Vacuum rating:**  
0.93 bar; 700 mm Hg

• **Specifications:**  
Hoses meet or exceed SAE J517-100R8, ISO 3949, DNV-GL Standards.

### Scheda tecnica - Data Sheet



CODE	inch	-dash	mm	DN	inch	mm	bar	psi	mm	inch	g/m	lbs/ft	FERRULE CODE
VE8M9447100	5/32"	-2.5	4.0	4	0.370	9.4	700	10150	30	1.18	57	0.038	BP5320L8M **
VE8M27100HP	3/16"	-3	4.8	5	0.444	11.3	700	10150	30	1.18	91	0.061	BP3160L8M
VE8M37100	1/4"	-4	6.4	6	0.583	14.8	700	10150	50	1.97	142	0.095	BP14R9R **
VE8M57100	3/8"	-6	9.7	10	0.630	16.0	350	5075	80	3.15	166	0.112	BP38R7V
VE8M57100HP	3/8"	-6	9.7	10	0.709	18.0	700	10150	90	3.54	190	0.128	BP38R9R **
VE8M67100	1/2"	-8	13.0	12	0.866	22.0	350	5075	100	3.94	278	0.187	BP12R9R **
VE8M87100	3/4"	-12	19.2	19	1.142	29.0	345	5002	205	8.07	403	0.271	BP34R9R **
VE8M97100	1"	-16	25.8	25	1.378	35.0	250	3625	230	9.06	486	0.311	BP1R9R **
VE8M1070100	1" 1/4	-20	32.0	32	1.772	45.0	250	3625	350	13.78	830	0.558	BP114MTKHM

\*\* Si raccomanda l'utilizzo di raccordi ZEC tipo TL o MULTISPIRAL.

\*\*We recommend the use of ZEC Fittings TL SERIES or MULTISPIRAL.

## MT1 OIL PROOF COVER



### Caratteristiche principali

- Pressione da 70 a 375 bar - rapporto sicurezza 1:4
- Pressione da 94 a 500 bar - rapporto sicurezza 1:3
- Normativa SAE 100R1, EN 853 1ST, 1SN - EN 857 1SC
- Soluzione conduttiva ad alta pressione per olii, polioli, solventi, vernici e gas compatibili

### Main Features

- Pressure from 70 to 375 bar - safety ratio 1:4
- Pressure from 94 to 500bar - safety ratio 1:3
- SAE 100R1, EN 853 1ST, 1SN - EN 857 1SC standards
- High pressure conductive solution for oils, polyols, solvents, paints and compatible gases

### Caratteristiche tecniche

- **Caratteristiche tecnico-costruttive:**  
Anima interna in poliammide, rinforzo in treccia acciaio ad alta resistenza e rivestimento esterno in poliuretano antiabrasione, a richiesta microperforato per passaggio aria e gas compatibili.
- **Temperature di utilizzo:**  
Da -40°C a +100°C Da -40°F a +212°F  
Per aria, acqua e fluidi a base acquosa la temperatura massima di esercizio è + 70°C (+158°F).
- **Pressioni d'esercizio:**  
Rapporto di sicurezza 1:4 per pressione DINAMICA  
Rapporto di sicurezza 1:3 per pressione STATICA
- **Valore max. di vuoto:**  
0,93 bar; 700 mm Hg
- **Specifiche:**  
Tubazioni conformi o superiori alle pressioni delle norme SAE 100R1 - EN 853 1ST, 1SN - EN 857 1SC.

### Technical Features

- **Technical-constructive features:**  
Inner core in polyamide, reinforcement in high tensile steel braid and exterior covering in antiabrasion polyurethane, micro perforated on request for the conduction of air and compatible gases.
- **Working temperature:**  
from -40°C to +100°C from -40°F to +212°F.  
Max. working temperature of air, water and water-based fluids is + 70°C (+158°F).
- **Working pressure:**  
Safety ratio 1:4 for Dynamic Pressure  
Safety ratio 1:3 for Static Pressure
- **Vacuum rating:**  
0.93 bar; 700 mm Hg
- **Specifications:**  
Hoses meet or exceed pressures under SAE 100R1 - EN 853 1ST, 1SN - EN 857 1SC Standards.

### Scheda tecnica - Data Sheet



CODE	inch	-dash	mm	DN	inch	mm	bar	psi	bar	psi	mm	inch	g/m	lbs/ft	FERRULE CODE
MT110000	1/8"	-2	3.5	3	0.295	7.5	375	5437	500	7250	30	1.18	76	0.051	BP18MT1
MT120000	3/16"	-3	4.8	5	0.394	10.0	350	5075	467	6772	30	1.18	131	0.088	BP316R7
MT130000	1/4"	-4	6.4	6	0.469	11.9	300	4350	400	5800	40	1.57	165	0.111	BP14MT1
MT140000	5/16"	-5	8.0	8	0.551	14.0	240	3480	320	4640	50	1.97	205	0.138	BP516R7V
MT150000	3/8"	-6	9.7	10	0.630	16.0	225	3262	300	4350	60	2.36	253	0.170	BP38R1TV
MT160000	1/2"	-8	13.0	12	0.756	19.2	190	2755	254	3683	75	2.95	314	0.211	BP12R2TV
MT170000	5/8"	-10	16.3	16	0.917	23.3	150	2175	200	2900	110	4.33	406	0.273	BP58R7V
MT180000	3/4"	-12	19.2	19	1.003	25.5	130	1885	174	2523	150	5.91	447	0.300	BP34R7V
MT190000	1"	-16	25.6	25	1.280	32.5	105	1520	140	2030	185	7.28	590	0.396	BP1R7V
MT1100000	1"1/4	-20	32.0	32	1.574	40.0	70	1015	94	1360	290	11.41	842	0.566	BP114JC7

## MT1E STATIC PRESSURE



### Caratteristiche principali

- Pressione da 350 a 190 bar - Solo per applicazioni statiche
- Soluzione conduttiva ad alta pressione per vernici e solventi

### Main Features

- Pressure from 350 to 190 bar - Static applications only
- High pressure conductive solution for paints and solvents

### Caratteristiche tecniche

- **Caratteristiche tecnico-costruttive:**  
Anima interna in polietilene, rinforzo con una treccia in acciaio ad alta resistenza, ricopertura esterna in poliuretano antiabrasione.
- **Temperature di utilizzo:**  
Da -20°C a +60°C (da -4°F a +140°F).
- **Pressioni d'esercizio:**  
Rapporto di sicurezza 1:4.  
Pressione da 350 a 190 bar - Solo per applicazioni statiche.

### Technical Features

- **Technical-constructive features:**  
Inner core in polyethylene, reinforcement in high tensile steel braid and exterior covering in antiabrasion polyurethane.
- **Working temperature:**  
from -20°C to +60°C (from -4°F to +140°F).
- **Working pressure:**  
Safety ratio 1:4.  
Pressure from 350 to 190 bar - Static applications only.

### Scheda tecnica - Data Sheet



CODE	inch	-dash	mm	DN	inch	mm	bar	psi	mm	inch	g/m	lbs/ft	FERRULE CODE
MT120000E	3/16"	-3	4.8	5	0.394	10.0	350	5075	30	1.18	126	0.085	BP316R7
MT130000E	1/4"	-4	6.4	6	0.469	11.9	300	4350	40	1.57	166	0.112	BP14MT1
MT140000E	5/16"	-5	8.0	8	0.551	14.0	240	3480	50	1.97	205	0.138	BP516R7V
MT150000E	3/8"	-6	9.7	10	0.630	16.0	225	3262	60	2.36	246	0.165	BP38R7V
MT160000E	1/2"	-8	13.0	12	0.756	19.2	190	2755	75	2.95	314	0.211	BP12R7V

## MT1-PA PA COVER



### Caratteristiche principali

- Pressione da 70 a 375 bar - rapporto sicurezza 1:4
- Pressione da 94 a 500 bar - rapporto sicurezza 1:3
- Soluzione conduttiva ad alta pressione per olii, polioli, solventi, vernici e gas compatibili
- Elevata resistenza chimica esterna

### Main Features

- Pressure from 70 to 375 bar - safety ratio 1:4
- Pressure from 94 to 500 bar - safety ratio 1:3
- High pressure conductive solution for oils, polyols, solvents, paints and compatible gases
- Cover's high chemical resistance

### Caratteristiche tecniche

- **Caratteristiche tecnico-costruttive:**  
Anima interna in poliammide, rinforzo in treccia acciaio ad alta resistenza e rivestimento esterno in poliammide particolarmente resistente a prodotti chimici aggressivi, a richiesta microperforato per passaggio aria e gas compatibili.
- **Temperature di utilizzo:**  
Da -40°C a +100°C Da -40°F a +212°F  
Per aria, acqua e fluidi a base acquosa la temperatura massima di esercizio è +70°C (+158°F).
- **Pressioni d'esercizio:**  
Rapporto di sicurezza 1:4 per pressione DINAMICA  
Rapporto di sicurezza 1:3 per pressione STATICA
- **Pressioni d'esercizio:**  
0.93 bar; 700 mm Hg
- **Pressioni d'esercizio:**  
Tubazioni conformi o superiori alle pressioni delle norme SAE 100R1 - EN 853 1ST, 1SN - EN 857 1SC.

### Technical Features

- **Technical-constructive features:**  
Inner core in polyamide, reinforcement in high tensile steel braid and exterior covering in polyamide, very resistant to aggressive chemicals, micro perforated on request for the conduction of air and compatible gases.
- **Working temperature:**  
from -40°C to +100°C from -40°F to +212°F.  
Max. working temperature of air, water and water-based fluids is +70°C (+158°F).
- **Working pressure:**  
Safety ratio 1:4 for DYNAMIC pressure  
Safety ratio 1:3 for STATIC pressure
- **Vacuum rating:**  
0.93 bar; 700 mm Hg
- **Specifications:**  
Hoses meet or exceed pressures under SAE 100R1 - EN 853 1st, 1SN - EN 857 1SC Standards.

### Scheda tecnica - Data Sheet



CODE	inch	-dash	mm	DN	inch	mm	bar	psi	bar	psi	mm	inch	g/m	lbs/ft	FERRULE CODE
MT113000	1/8"	-2	3.5	3	0.295	7.5	375	5437	500	7250	30	1.18	73	0,049	BP18MT1
MT123000	3/16"	-3	4.8	5	0.394	10.0	350	5075	467	6772	30	1.18	127	0,085	BP316R7
MT133000	1/4"	-4	6.4	6	0.469	11.9	300	4350	400	5800	40	1.57	157	0,106	BP14MT1
MT143000	5/16"	-5	8.0	8	0.551	14.0	240	3480	320	4640	50	1.97	195	0,131	BP516R7V
MT153000	3/8"	-6	9.7	10	0.630	16.0	225	3262	300	4350	60	2.36	241	0,162	BP38R1TV
MT163000	1/2"	-8	13.0	12	0.756	19.2	190	2755	254	3683	75	2.95	299	0,201	BP12R2TV
MT173000	5/8"	-10	16.3	16	0.917	23.3	150	2175	200	2900	110	4.33	384	0,258	BP58R7V
MT183000	3/4"	-12	19.2	19	1.003	25.5	130	1885	174	2523	150	5.91	429	0,288	BP34R7V
MT193000	1"	-16	25.6	25	1.280	32.5	105	1520	140	2030	185	7.28	547	0,368	BP1R7V



## MT2 OIL PROOF COVER



### Caratteristiche principali

- Pressione da 165 a 400 bar - rapporto sicurezza 1:4
- Pressione da 220 a 534 bar - rapporto sicurezza 1:3
- Normativa SAE 100R2
- Soluzione conduttiva ad alta pressione per vernici, solventi e sistemi di schiumatura ed iniezione poliuretanica

### Main Features

- Pressure from 165 to 400 bar - safety ratio 1:4
- Pressure from 220 to 534 bar - safety ratio 1:3
- SAE 100R2 Standard
- High pressure conductive solution for paints, solvents, foaming and PU injection systems

### Caratteristiche tecniche

- **Caratteristiche tecnico-costruttive:**  
Anima interna in poliammide, rinforzo con doppia treccia acciaio ad alta resistenza e rivestimento esterno in poliuretano antiabrasione, a richiesta microperforato per passaggio aria e gas compatibili.
- **Temperature di utilizzo:**  
Da -40°C a +100°C Da -40°F a +212°F  
Per aria, acqua e fluidi a base acquosa la temperatura massima di esercizio è + 70°C (+158°F).
- **Pressioni d'esercizio:**  
Rapporto di sicurezza 1:4 per pressione DINAMICA  
Rapporto di sicurezza 1:3 per pressione STATICA
- **Valore max. di vuoto:**  
0,93 bar; 700 mm Hg
- **Specifiche:**  
Tubazioni conformi o superiori alle pressioni della norma SAE 100R2.

### Technical Features

- **Technical-constructive features:**  
Inner core in polyamide, reinforcement in double high tensile steel braid and exterior covering in antiabrasion polyurethane, micro perforated on request for the conduction of air and compatible gases.
- **Working temperature:**  
from -40°C to +100°C from -40°F to +212°F.  
Max. working temperature of air, water and water-based fluids is + 70°C (+158°F).
- **Working pressure:**  
Safety ratio 1:4 for DYNAMIC pressure  
Safety ratio 1:3 per STATIC pressure
- **Vacuum rating:**  
0.93 bar; 700 mm Hg
- **Specifications:**  
Hoses meet or exceed pressures of the SAE 100R2 Standard.

### Scheda tecnica - Data Sheet



CODE	inch	-dash	mm	DN	inch	mm	bar	psi	bar	psi	mm	inch	g/m	lbs/ft	FERRULE CODE
MT230000	1/4"	-4	6.4	6	0.531	13.5	400	5800	534	7740	40	1.57	286	0.192	BP14R2TV
MT240000	5/16"	-5	8.0	8	0.594	15.1	350	5075	467	6772	50	1.97	340	0.228	BP38R7V
MT250000	3/8"	-6	9.7	10	0.669	17.0	300	4785	440	6380	60	2.36	408	0.274	BP38R2T
MT260000	1/2"	-8	13.0	12	0.846	21.5	275	3988	367	5322	75	2.95	582	0.391	BP12R2TV
MT270000	5/8"	-10	16.3	16	0.965	24.5	250	3625	334	4843	110	4.33	639	0.429	BP34R7V
MT280000	3/4"	-12	19.2	19	1.083	27.5	215	3118	287	4162	150	5.91	765	0.514	BP34JC7
MT290000	1"	-16	25.6	25	1.378	35.0	165	2400	220	3190	185	7.28	1026	0.689	BP1R1T

## MT2Y OIL PROOF COVER



### Caratteristiche principali

- Soluzione conduttiva ad alta pressione per vernici, solventi e sistemi di schiumatura ed iniezione poliuretanica
- Soluzione economica a pressione costante (450 bar / 6,500 PSI)

### Main Features

- High pressure conductive solution for paints, solvents, foaming and PU injection systems
- Economic and isobaric pressure solution (450 bar / 6,500 PSI)

### Caratteristiche tecniche

#### • Caratteristiche tecnico-costruttive:

Anima interna in poliammide, rinforzo con doppia treccia acciaio ad alta resistenza e rivestimento esterno in poliuretano antiabrasione, a richiesta microforato per passaggio aria e gas compatibili.

#### • Temperature di utilizzo:

Da -40°C a +100°C Da -40°F a +212°F

Per aria, acqua e fluidi a base acquosa la temperatura massima di esercizio è + 70°C (+158°F).

#### • Valore max. di vuoto:

0,93 bar; 700 mm Hg

#### • Specifiche:

Tubazioni conformi o superiori alle pressioni della norma SAE 100R2.

### Technical Features

#### • Technical-constructive features:

Inside core in polyamide, reinforcement in high tensile steel braids, outside cover in antiabrasion blue colored polyurethane. On request it is also available in pinpricked version for air and compatible gases.

#### • Working temperature:

from -40°C to +100°C from -40°F to +212°F.

Max. working temperature of air, water and water-based fluids is + 70°C (+158°F).

#### • Vacuum rating:

0.93 bar; 700 mm Hg

#### • Specifications:

Hoses meet or exceed pressures of the SAE 100R2 Standard.

### Scheda tecnica - Data Sheet



CODE	inch	-dash	mm	DN	inch	mm	bar	psi	bar	psi	mm	inch	g/m	lbs/ft	FERRULE CODE
MT2Y30003	1/4"		6.4		0.531	13.5	450	6527	1800	26107	40	1.57	296	0.199	BP14R2TV
MT2Y50003	3/8"		9.7		0.669	17.0	450	6527	1800	26107	60	2.36	413	0.277	BP38R2T

## MTK WATER PROOF COVER

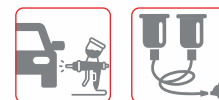

### Caratteristiche principali

- Pressione da 200 a 700 bar / 10,000 PSI
- Normativa DNV-GL, MSHA
- Soluzione conduttiva ad altissima pressione per olii, vernici, solventi e sistemi di schiumatura ed iniezione poliuretanic

### Main Features

- Pressure range from 200 to 700 bar / 10,000 PSI
- DNV-GL, MSHA standards
- High pressure conductive solution for oils, paints, solvents, foaming and injection systems

### Caratteristiche tecniche

**Caratteristiche tecnico-costruttive:**  
Anima interna in poliammide, rinforzo con treccia ibrida in fibra aramidica ed acciaio ad alta resistenza, rivestimento esterno in poliuretano antiabrasione, stabilizzato ai raggi UV, resistente all'ozono, ai microorganismi ed all'idrolisi, adatto per applicazioni all'esterno in ambienti particolarmente umidi e salini, a richiesta microforato per passaggio aria e gas compatibili.

**Temperature di utilizzo:**  
Da -40°C a +100°C Da -40°F a +212°F.  
Per aria, acqua e fluidi a base acquosa la temperatura massima di esercizio è +70°C (+158°F).

**Pressioni d'esercizio:**  
Rapporto di sicurezza 1:4

**Valore max. di vuoto:**  
0.93 bar; 700 mm Hg

### Technical Features

**Technical-constructive features:**  
Inner core in polyamide, hybrid reinforcement in aramid fibre and high tensile steel braid, outside cover in abrasion resistant polyurethane, UV-stabilized, resistant to ozone, microorganisms and hydrolysis, suitable for outdoor applications in wet and saline environments, pinpricked on request for conduction of air and compatible gases.

**Working temperatures:**  
From -40°C to +100°C From -40°F to +212°F.  
Max. working temperature with air, water and water-based fluids is +70°C (+158°F).

**Working pressure:**  
Safety ratio 1:4

**Vacuum rating:**  
0.93 bar; 700 mm Hg

### Scheda tecnica - Data Sheet



CODE	inch	-dash	mm	DN	inch	mm	bar	psi	mm	inch	g/m	lbs/ft	FERRULE CODE
MTK27000	3/16"	-3	4.8	5	0.445	11.3	500	7250	30	1.18	167	0.112	BP316MTK
Δ MTK37000	1/4"	-4	6.4	6	0.571	14.5	700	10150	40	1.57	254	0.171	BP14R9R **
MTK47000	5/16"	-5	8.0	8	0.630	16.0	500	7250	50	1.97	292	0.196	BP516MTK
MTK57000	3/8"	-6	9.5	10	0.709	18.0	425	6162	60	2.36	340	0.228	BP38R9R **
MTK67000	1/2"	-8	13.0	12	0.866	22.0	375	5437	75	2.95	448	0.301	BP12R9R **
MTK77000	5/8"	-10	16.0	16	0.984	25.0	250	3625	110	4.33	510	0.343	BP58R9R **
MTK87000	3/4"	-12	19.2	19	1.110	28.2	225	3625	150	5.91	600	0.403	BP34R9R **
MTK97000	1"	-16	25.8	25	1.394	35.4	200	2900	250	9.84	810	0.544	BP1R9R **

\*\* Si raccomanda l'utilizzo di Raccordi ZEC tipo TL o MULTISPIRAL.  
Δ Tubazione idonea per attrezzature di soccorso (Norma NFPA 1936), applicazioni con martinetti idraulici.

\*\*We recommend the use of ZEC Fittings TL SERIES or MULTISPIRAL.  
Δ Hose suitable for rescue tools (NFPA 1936 Standard), hydraulic jacks applications.

## MTKM WATER PROOF COVER



### Caratteristiche principali

- Pressione da 275 a 800 bar
- Normativa DNV-GL, MSHA
- Soluzione conduttiva ad altissima pressione per olii, vernici, solventi e sistemi di schiumatura ed iniezione poliuretanic

### Caratteristiche tecniche

- **Caratteristiche tecnico-costruttive:**  
Anima interna in poliammide, rinforzo con treccia ibrida in fibra aramidica ed acciaio ad alta resistenza, rivestimento esterno in poliuretano antiabrasione, stabilizzato ai raggi UV, resistente all'ozono, ai microorganismi ed all'idrolisi, adatto per applicazioni all'esterno in ambienti particolarmente umidi e salini, a richiesta microforato per passaggio aria e gas compatibili.
- **Temperature di utilizzo:**  
Da -40°C a +100°C Da -40°F a +212°F.  
Per aria, acqua e fluidi a base acquosa la temperatura massima di esercizio è +70°C (+158°F).
- **Valore Max. di vuoto:**  
0.93 bar; 700 mm Hg
- **Pressioni d'esercizio:**  
Rapporto di sicurezza 1:4  
# Rapporto di sicurezza 1:3.75
- **Specifiche:**  
Δ Tubazioni idonee per attrezzature di soccorso, applicazioni con martinetti idraulici e DNV-GL, MSHA.

### Scheda tecnica - Data Sheet



CODE	inch	-dash	mm	DN	inch	mm	bar	psi	mm	inch	g/m	lbs/ft	FERRULE CODE
MTKM37000 (Δ)	1/4"	-4	6.4	6	0.571	14.5	800	11600	40	1.57	248	0.170	BP14R9R **
MTKM57000 (Δ)	3/8"	-6	9.7	10	0.740	18.8	700	10150	90	3.54	375	0.257	BP38MTKM **
MTKM67000 (Δ)	1/2"	-8	13.0	12	0.992	25.2	700	10150	140	5.51	588	0.395	BP12MTKM #
MTKM77000	5/8"	-10	16.0	16	1.024	26.0	350	5075	200	7.87	557	0.374	BP58MTKM **
MTKM87000	3/4"	-12	19.2	19	1.188	30.2	325	4710	230	9.06	695	0.467	BP34MTKM **
MTKM97000	1"	-16	25.8	25	1.496	38.0	325	4710	250	9.84	972	0.653	BP1MTKM **
MTKM107000	1 1/4"	-20	32.0	32	1.780	45.2	275	3990	350	13.78	1206	0.810	BP114MTKHM

\*\* Si raccomanda l'utilizzo di Raccordi ZEC tipo TL o MULTISPIRAL.  
# Si raccomanda l'utilizzo di Raccordi ZEC tipo TL o MULTISPIRAL speciali.

\*\* We recommend the use of ZEC Fittings TL SERIES or MULTISPIRAL.  
# We recommend the use of ZEC Fittings TL SERIES or MULTISPIRAL SPECIAL.

## VE5+PU



### Caratteristiche principali

- Tubi binati alta-bassa pressione
- Soluzione compatta e flessibile per verniciatura e schiumatura poliuretanica

### Main Features

- High-low pressure twin hoses
- Compact and flexible solution for paint and PU foaming

### Caratteristiche tecniche

#### • Caratteristiche tecnico-costruttive:

Le tubazioni della SERIE TUBI BINATI ALTA-BASSA PRESSIONE sono costruite per il settore della verniciatura industriale.

Nel tubo alta pressione è previsto il passaggio della vernice e nel tubo bassa pressione aria.

#### • Temperature di utilizzo:

Da -20°C a +65°C Da -4°F a +149°F

### Technical Features

#### • Technical-constructive features:

The HIGH-LOW PRESSURE TWIN HOSES SERIES is intended for industrial painting.

The high pressure hose is for the flow of paint and the low pressure hose is for the flow of air.

#### • Working temperatures:

From -20°C to +65°C From -4°F to +149°F

### Scheda tecnica - Data Sheet



CODE	inch	-dash	mm	DN	inch	mm	bar	psi	bar	psi	mm	inch	g/m	lbs/ft
VE520000PU85BB	VE5 3/16"	-3	4.8	5	0.362	9.2	200	2900	800	11603	30	1.18	94	0.063
	PU 8x5		5.0		0.314	8.0	17	247	52	754				

## MT1+PA



### Caratteristiche principali

- Soluzione compatta e ad alta resistenza a meccanica
- Ideale per applicazioni di schiumatura poliuretanic a applicazione stucco in campo edilizio

### Main Features

- Compact and high mechanical resistance solution
- Ideal solution for PU foaming and grouting applications

### Caratteristiche tecniche

#### • Caratteristiche tecnico-costruttive:

Le tubazioni della SERIE TUBI BINATI ALTA-BASSA PRESSIONE sono costruite per il settore della verniciatura industriale. Nel tubo alta pressione è previsto il passaggio della vernice e nel tubo bassa pressione aria.

MT1: anima interna in poliammide, rinforzo in treccia d'acciaio ad alta resistenza, rivestimento esterno in poliuretano antiabrasione, a richiesta disponibile anche in versione microforata per aria e gas compatibili.

PA12: Poliammide PA12 tipo S40.

#### • Temperature di utilizzo:

Da -40°C a +100°C      Da -40°F a +212°F.

Da -40°C to +80°C      Da -40°F to 176°F.

Per aria, acqua e fluidi a base acquosa la temperatura massima di esercizio è +70°C (+158°F).

#### • Valore Max. di vuoto:

0.93 bar; 700 mm Hg

#### • Specifiche:

Lunghezze standard: 27 e 52 metri. Disponibilità di altre pezzature su richiesta.

### Technical Features

#### • Technical-constructive features:

The HIGH-LOW PRESSURE TWIN HOSES SERIES is intended for industrial painting. The high pressure hose is for the flow of paint and the low pressure hose is for the flow of air.

MT1: internal core in polyamide, reinforcement in high tensile steel braid, exterior covering in antiabrasion polyurethane, on request it is also available in micro perforated version for air and compatible gas.

PA12: Polyamide PA12 type S40.

#### • Working temperatures:

From -40°C to +100°C      From -40°F to +212°F.

From -40°C to +80°C      From -40°F to 176°F.

Max. working temperature with air, water and water-based fluids is +70°C (+158°F).

#### • Vacuum rating:

0.93 bar; 700 mm Hg

#### • Specifications:

Standard lengths: 27 and 52 meters. Other lengths can be manufactured upon request.

### Scheda tecnica - Data Sheet



CODE	inch	mm	inch	mm	bar	psi	bar	psi	mm	inch	g/m	lbs/ft
MT16000TA63TR** (TA63T40)	1/2"	13	0.756	19.2	760	11023	190	2755	75	2.95	335.8	0.225
MT18000TA63TR** (TA63T40)	3/4"	19.2	1.003	25.5	520	7540	130	1885	150	5.91	468.8	0.315

\*\* 27 metri o 52 metri.

\*\* 27 meters or 52 meters.

*Paint Spray / Solvents / Injection*



## Le soluzioni ZEC per la gestione di gas industriali

ZEC offre una gamma di tubi termoplastici progettati per la conduzione di gas di vario tipo in ambito industriale, quali: Gas Naturale, Metano, CO<sub>2</sub>, gas compatibili e aria respirabile.

### CARATTERISTICHE TECNICHE

- Elevata flessibilità e resistenza al kinking
- Resistenti alle sollecitazioni, alla corrosione e agli effetti ambientali

### APPLICAZIONI



RIFORNIMENTO  
E RICARICA  
CNG

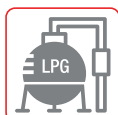

STAZIONI  
GPL



ARIA  
RESPIRABILE



GESTIONE GAS  
E FLUIDI

### CERTIFICAZIONI

Tutti i tubi ZEC sono prodotti in conformità al **Regolamento Europeo CE 1907/2006 "REACH"** e alla **Direttiva Europea UE 65/2011 "RoHS"**.

### QUALITÀ

Il sistema di qualità certificato **ISO 9001:2015 ZEC** assicura un controllo continuo e costante del processo produttivo, garantendo il rispetto delle buone pratiche di fabbricazione.

## ZEC Solutions for Gas Handling

ZEC offers a range of thermoplastic hoses designed for gas handling in industrial applications, such as: CNG, LPG, CO<sub>2</sub>, compatible gases and breathing air.

### TECHNICAL FEATURES

- Extremely flexible and kinking resistant
- Resistant to stress, corrosion and environmental effects

### APPLICATIONS



CNG  
DISPENSING



LPG  
STATION



BREATHING  
AIR



GAS AND  
FLUIDS  
HANDLING

### CERTIFICATIONS

All ZEC hoses are manufactured in conformity to **European Regulation EU 1907/2006 "REACH"** and **European Directive EU 2011/65 "RoHS"**.

### QUALITY

The certified **ISO 9001:2015 ZEC** quality system ensures a continuous and constant control of the production process, guaranteeing compliance with Good Manufacturing Practices.





# GAS5 CONDUCTIVE WATERPROOF COVER



## Caratteristiche principali

- Pressione costante 35 bar
- Tubazione conduttiva creata per la conduzione di GPL
- Soluzione idonea per installazione interrata, alternativa a tubazioni in acciaio

## Main Features

- Constant pressure at 35 bar
- Conductive hose solution for LPG handling
- Ideal solution for underground installation, in alternative to steel piping

## Caratteristiche tecniche

### Caratteristiche tecnico-costruttive:

Anima interna in poliammide conduttiva, rinforzo con doppia treccia in filato poliestere e ricopertura esterna in esterno in poliuretano antiabrasione e resistente all'idrolisi stabilizzato per applicazioni all'esterno, in ambienti particolarmente umidi e salini, micro perforato, stabilizzato ai raggi UV e resistente ai microrganismi.

### Temperature di utilizzo:

Da -40°C a +70°C. Da -40°F a +158°F

### Pressioni d'esercizio:

Rapporto di sicurezza 1:4

### Valore max. di vuoto:

0.93 bar; 700 mm Hg

### Specifiche:

Pezzature massime:

300m - 1/2" e 3/4"

180m - 1"1/4

## Technical Features

### Technical-constructive features:

Inner core in electrically conductive polyamide, reinforcement in double polyester fiber braid and external covering in exterior covering in antiabrasion polyurethane and resistant to stabilized hydrolysis for outdoor applications, in environments having high humidity and saline levels, micro perforated, stabilized against UV rays and microorganisms-resistant.

### Working temperatures:

from -40°C to +70°C. From -40°F to +158°F

### Working pressure:

Safety ratio 1:4

### Vacuum rating:

0.93 bar; 700 mm Hg

### Specifications:

Maximum lengths:

300mt - 1/2" and 3/4"

180mt - 1"1/4

## Scheda tecnica - Data Sheet



CODE	inch	-dash	mm	DN	inch	mm	bar	psi	mm	inch	g/m	lbs/ft	FERRULE CODE
GAS567100	1/2"	-8	13.0	12	0.799	20.3	35	507	95	3.74	255	0.171	BP112R7V
GAS587100	3/4"	-12	19.2	19	1.043	26.5	35	507	180	7.08	360	0.242	BP134R7
GAS5107100	1" 1/4	-20	32.0	32	1.700	43.2	35	507	350	13.77	485	0.326	BP1114R2

## CNG WATERPROOF COVER



### Caratteristiche principali

- Pressione costante 345 bar
- Tubazione conduttiva creata per la conduzione di Gas Metano per rifornimento e trasbordo
- Tubazioni dal design robusto, in grado di resistere a sollecitazioni, corrosione ed effetti ambientali
- Disponibili anche in soluzione binata con tubo di ventilazione

### Main Features

- Constant pressure at 345 bar
- Conductive hose solution for CNG handling, for service stations and gas transportation
- Heavy duty design, resistant to corrosion, heavy handling and bad environmental conditions
- Available also in twin hose solution with venting hose

### Caratteristiche tecniche

#### • Caratteristiche tecnico-costruttive:

Anima interna in poliammide conduttiva, rinforzo con trecce in fibre tessili ad alta tenacità, ricopertura esterna in poliuretano ROSSO waterproof, antiabrasione, microperforato.

Disponibili a richiesta in versione BINATA o MULTIPLA.

La resistenza elettrica della tubazione risulta inferiore a 0,12 MΩ/m secondo la norma ISO 8031.

#### • Temperature di utilizzo:

Da -40°C a +85°C    Da -40°F a +185°F

#### • Pressioni d'esercizio:

Rapporto di sicurezza 1:4

#### • Valore max. di vuoto:

0,93 bar; 700 mm Hg

#### • Specifiche:

Tubazioni conformi o superiori alla norma ISO 15500-17, MSHA. Superano i requisiti NFPA 52, ANSI/CSA NGV 4.2-2014 e CSA 12.52-2014.

Certificati da IRAM secondo normativa NAG E409:2005.

### Technical Features

#### • Technical-constructive features:

Inner core in electrically conductive polyamide, reinforcement in high toughness textile fiber braid, external pin-pricked anti-abrasion RED waterproof polyurethane covering. Twin-line or multi-line version available on request. The electric resistance of the hose is less than 0.12 MΩ/m in accordance with ISO 8031 standard.

#### • Working temperatures:

from -40°C to +85°C (from -40°F to +185°F)

#### • Working pressure:

Safety ratio 1:4

#### • Vacuum rating:

0.93 bar; 700 mm Hg

#### • Specifications:

Hoses meet or exceed ISO 15500-17, MSHA standards. Exceed NFPA 52, ANSI/CSA NGV 4.2-2014 and CSA 12.52-2014 requirements.

Certified by IRAM according to NAG E409:2005 standard.

### Scheda tecnica - Data Sheet



CODE	inch	-dash	mm	DN	inch	mm	bar	psi	mm	inch	g/m	lbs/ft	FERRULE CODE
CNG37105	1/4"	-4	6.4	6	0.492	12.5	345	5000	45	1.77	105	0.071	BP14MT1
CNGM37105*	1/4"	-4	6.4	6	0.591	15.0	345	5000	50	1.97	162	0.109	BP14MT2
CNG47105	5/16"	-5	8.0	8	0.591	15.0	345	5000	60	2.36	142	0.095	BP516R7V
CNG57105	3/8"	-6	9.7	10	0.650	16.5	345	5000	75	2.95	155	0.104	BP38R7V
CNG67105	1/2"	-8	13.0	12	0.866	22.0	345	5000	95	3.74	245	0.165	BP12R9R
CNG87105	3/4"	-12	19.2	19	1.142	29.0	345	5000	185	7.28	360	0.242	BP34MTKM
CNG97105	1"	-16	25.6	25	1.515	38.5	345	5000	230	9.06	510	0.343	BP1MTKM

\* Soluzione "anti-kinking" raccomandata in particolare per collegamento valvola ed attacco veicolo.

\* "Anti-kinking" solution recommended especially for valve connection and vehicle coupling.

## OIL&GAS - HOG WATERPROOF COVER



### Caratteristiche principali

- Pressione da 345 a 1034 bar
- Normativa ISO 13628-5, API 17E, SAE J517-100R8, ISO 3949, DNV-GL, MSHA
- Ideali per circuiti idraulici su piattaforme o sottomarini, iniezioni e metanolo, sistemi BOP, veicoli sottomarini a comando remoto, gestione bordo nave o piattaforma di gas compatibili

### Caratteristiche tecniche

- **Caratteristiche tecnico-costruttive:**  
Anima interna in poliammide, rinforzo in fibra aramidica, rivestimento esterno in poliuretano antiabrasione, stabilizzato ai raggi UV, resistente all'ozono, ai microorganismi ed all'idrolisi, adatto per applicazioni all'esterno in ambienti particolarmente umidi e salini, microforato per passaggio aria e gas compatibili.
- **Temperature di utilizzo:**  
Da -40°C a +55°C.
- **Pressioni d'esercizio:**  
Rapporto di sicurezza 1:4, tubazioni consigliate per applicazioni dinamiche.  
(\*\*) Rapporto di sicurezza 1:3, tubazioni adatte per applicazioni statiche e con ridotti impulsi di pressione.
- **Valore max. di vuoto:**  
0.93 bar; 700 mm Hg
- **Specifiche:**  
Progettato e costruito in accordo ai requisiti delle normative API 17E / ISO 13628-5.

### Main Features

- Pressure from 345 to 1034 bar
- ISO 13628-5, API 17E, SAE J517-100R8, ISO 3949, DNV-GL, MSHA standards
- Ideal for rigs or subsea hydraulic circuits, methanol injection, BOP systems, remotely operated subsea vehicles, handling of compatible gases on rigs/vessels

### Technical Features

- **Technical-constructive features:**  
Inner core in polyamide, reinforcement in aramid fibre, outside cover in abrasion resistant polyurethane, UV-stabilized, resistant to ozone, microorganisms and hydrolysis, suitable for outdoor applications in wet and saline environments, pinpricked for conduction of air and compatible gases.
- **Working temperatures:**  
From -40° to +55°C Max.
- **Working pressure:**  
Safety ratio 1:4, hoses suitable for dynamic applications.  
(\*\*) Safety ratio 1:3, hoses suitable for static applications and with reduced pressure impulse.
- **Vacuum rating:**  
0.93 bar; 700 mm Hg
- **Specifications:**  
Designed and manufactured according to requirements of API 17E / ISO 13628-5 standards.

### Scheda tecnica - Data Sheet



CODE	inch	-dash	mm	DN	inch	mm	bar	psi	mm	inch	g/m	lbs/ft	FERRULE CODE
HOG827100 (Δ)	3/16"	-3	4.8	5	0.394	10.0	345	5000	35	1.38	72	0.048	BPI316R7
HOG837100 (Δ)	1/4"	-4	6.4	6	0.465	11.8	345	5000	50	1.97	84	0.056	BPI14R7
HOG8M37100 (#)	1/4"	-4	6.4	6	0.583	14.8	689	10000	50	1.97	152	0.102	BPI14R9R (1)
HOG8M37100K3 (**)	1/4"	-4	6.4	6	0.583	14.8	1034	15000	50	1.97	152	0.102	BPI14R9R (1)
HOG857100 (Δ)	3/8"	-6	9.7	10	0.630	16.0	345	5000	80	3.15	139	0.093	BPI38R7V
HOG8M57100 (#)	3/8"	-6	9.7	10	0.709	18.0	689	10000	90	3.54	197	0.132	BPI38R9R
HOG867100 (Δ)	1/2"	-8	13.0	12	0.866	22.0	345	5000	100	3.94	274	0.184	BPI12R9R (1)
HOG8M67100K3 (**)	1/2"	-8	13.0	12	0.945	24.0	689	10000	110	3.94	348	0.234	BPI12HOG8M (2)
HOG887100 (#)	3/4"	-12	19.1	19	1.134	28.8	345	5000	210	8.27	420	0.282	BPI34R9R (1)
HOG897100 (#)	1"	-16	25.4	25	1.465	37.2	345	5000	230	9.06	587	0.394	BPI1MTKM (1)

(Δ) conformi o superiori a SAE J1517-100R8, ISO 3949, DNV-GL, MSHA.  
(#) con pressioni superiori alla norma SAE J517 100R8.  
(1) Raccordi TL o Multispiral (2) Raccordi speciali

(Δ) meet or exceed SAE J1517-100R8, ISO 3949, DNV-GL, MSHA Standards.  
(#) with pressures exceeding SAE J517 100R8 Standard.  
(1) TL or Multispiral fittings (2) Special fittings

## AT7 WATERPROOF COVER



### Caratteristiche principali

- Pressione da 70 a 250 bar
- Normativa SAE 100R7, ISO 3949, FDA 21 CFR, EU 10/2011
- Le tubazioni della serie AT7 sono state create per la conduzione di fluidi alimentari a media pressione.

### Main Features

- Pressure from 70 to 250 bar
- Compliance with sae 100r7, iso 3949, fda 21 cfr, eu 10/2011 standards
- AT7 series hoses have been created for the medium pressure conduction of food fluids.

### Caratteristiche tecniche

#### • Caratteristiche tecnico-costruttive:

Anima interna in polimero termoplastico idoneo per il contatto con alimenti, rinforzo in fibra poliestere ed esterno in poliuretano antiabrasione stabilizzato ai raggi UV e resistente all'idrolisi e ai microrganismi. Tubi microperforati per passaggio aria e gas compatibili.

#### • Temperature di utilizzo:

Da -40°C a +82°C (da -40°F a +180°F).

Per aria, acqua e fluidi a base acquosa la temperatura massima di esercizio è +70°C (+158°F).

#### • Pressioni d'esercizio:

Rapporto di sicurezza 1:4

#### • Valore max. di vuoto:

0.93 bar; 700 mm Hg

#### • Specifiche:

Tubazioni conformi o superiori alle norme SAE J517 sez. SAE 100R7 - ISO 3949. Reg. CE 1935/2004, Reg. UE 10/2011. Simulanti A, B, C e D1. Condizioni standardizzate OM4. Da non utilizzare con cibi grassi. FDA 21 CFR 177.2600. Utilizzabile con tutti i cibi fino a 65°C e con contenuto di alcool inferiore all'8%. D.M. 174 del 06/04/2004 utilizzo con acqua potabile.

### Technical Features

#### • Technical-constructive features:

Inner core in thermoplastic polymer suitable to be in contact with food, polyester textile reinforcement and exterior covering in antiabrasion polyurethane stabilized against UV rays and resistant to hydrolysis and microorganisms, micro perforated for air and compatible gases.

#### • Working temperatures:

From -40°C to +82°C (-40°F to +180°F).

Max. working temperature with air, water and fluids containing water: +70°C (+158°F).

#### • Working pressure:

Safety ratio 1:4

#### • Vacuum rating:

0.93 bar; 700 mm Hg

#### • Specifications:

These hoses meet or exceed standards SAE J517 sec. SAE 100R7 - ISO 3949. Reg. EC 1935/2004, Reg. EU 10/2011. Simulants A, B, C and D1. Standardised testing conditions OM4. Do not use in contact with fatty foods. FDA 21 CFR 177.2600. To use with all type of food up to 149°F and containing less than 8% alcohol. D.M. 174 of 06/04/2004 for use in the drinking water supply chain.

### Scheda tecnica - Data Sheet



CODE	inch	mm	-dash	DN	inch	mm	bar	psi	mm	inch	g/m	lbs/ft	FERRULE CODE
AT717100	1/8"	3.5	-2	3	0.335	8.5	230	3335	12	0.47	57	0.038	BPI18R7
AT78947100	5/32"	4	-2.5	4	0.350	8.9	250	3625	25	0.98	58	0.039	BPI532R7
AT727100	3/16"	4.8	-3	5	0.394	10	210	3045	30	1.18	73	0.049	BPI316R7
AT737100	1/4"	6.4	-4	6	0.465	11.8	200	2900	35	1.38	90	0.060	BPI14R7
AT747100	5/16"	8	-5	8	0.563	14.3	190	2755	45	1.77	128	0.086	BPI516R7V
AT757100	3/8"	9.7	-6	10	0.630	16	175	2537	55	2.17	155	0.104	BPI38R7V
AT767100	1/2"	13	-8	12	0.799	20.3	140	2030	75	2.95	219	0.147	BPI12R7V
AT777100	5/8"	16	-10	16	0.925	23.5	105	1522	120	4.72	277	0.186	BPI58R7
AT787100	3/4"	19.2	-12	19	1.043	26.5	90	1305	145	5.71	330	0.222	BPI34R7
AT797100	1"	25.6	-16	25	1.322	32.5	70	1015	200	7.87	403	0.271	BPI1R8

## AT8 WATERPROOF COVER



### Caratteristiche principali

- Pressione da 165 a 350 bar
- Normativa SAE 100R8, ISO 3949, FDA 21 CFR, EU 10/2011
- Le tubazioni della serie AT8 sono state create per la conduzione di fluidi alimentari ad alta pressione

### Main Features

- Pressure from 165 to 350 bar
- Compliance with SAE 100R8, ISO 3949, FDA 21 CFR, EU 10/2011 standards
- AT8 series hoses have been created for the high pressure conduction of food fluids.

### Caratteristiche tecniche

• **Caratteristiche tecnico-costruttive:**  
Anima interna in polimero termoplastico idoneo per il contatto con alimenti, rinforzo in fibre ad alta tenacità ed esterno in poliuretano antiabrasione stabilizzato ai raggi UV e resistente all'idrolisi e ai microrganismi. Tubi microperforati per passaggio aria e gas compatibili.

• **Temperature di utilizzo:**  
Da -40°C a +82°C (da -40°F a +180°F).  
Per aria, acqua e fluidi a base acquosa la temperatura massima di esercizio è +70°C (+158°F).

• **Pressioni d'esercizio:**  
Rapporto di sicurezza 1:4.

• **Valore max. di vuoto:**  
0.93 bar; 700 mm Hg.

• **Specifiche:**  
Tubazioni conformi o superiori alle norme SAE J517 sez. SAE 100R8 - ISO 3949.  
Reg. CE 1935/2004. Reg. UE 10/2011. Simulanti A, B, C e D1. Condizioni standardizzate OM4. Da non utilizzare con cibi grassi. FDA 21 CFR 177.2600. Utilizzabile con tutti i cibi fino a 65°C e con contenuto di alcool inferiore all'8%.  
D.M. 174 del 06/04/2004 utilizzo con acqua potabile.

### Technical Features

• **Technical-constructive features:**  
Inner core in thermoplastic polymer suitable to be in contact with food, high tenacity textile reinforcement and exterior covering in antiabrasion polyurethane stabilized against UV rays and resistant to hydrolysis and microorganisms, micro perforated for air and compatible gases.

• **Temperature range:**  
From -40°C to +82°C (-40°F to +180°F).  
Max. working temperature with air, water and fluids containing water: +70°C (+158°F).

• **Working pressure:**  
Safety ratio 1:4

• **Vacuum Rating:**  
13.5 psi; 27.5 inch Hg

• **Specifications:**  
These hoses meet or exceed standards SAE J517 sec. SAE 100R8 - ISO 3949.  
Reg. EC 1935/2004. Reg. EU 10/2011. Simulants A, B, C and D1. Standardised testing conditions OM4. Do not use in contact with fatty foods.  
FDA 21 CFR 177.2600. To use with all type of food up to 149°F and containing less than 8% alcohol.  
D.M. 174 of 06/04/2004 for use in the drinking water supply chain.

### Scheda tecnica - Data Sheet



CODE	inch	mm	-dash	DN	inch	mm	bar	psi	mm	inch	g/m	lbs/ft	FERRULE CODE
AT827100	3/16"	4.8	-3	5	0.394	10	350	5075	1.38	35	72	0.048	BPI316R7
AT837100	1/4"	6.4	-4	6	0.465	11.8	350	5075	1.97	50	97	0.065	BPI14R7
AT857100	3/8"	9.7	-6	10	0.630	16	280	4060	2.76	70	149	0.100	BPI38R7V
AT867100	1/2"	13	-8	12	0.799	20.3	245	3552	3.74	95	225	0.151	BPI12R7V
ATT887100	3/4"	19.2	-12	19	1.043	26.5	165	2390	5.91	150	352	0.237	BPI34R7V

# AT8S - BREATHING AIR

## WATERPROOF COVER



### Caratteristiche principali

- Pressione costante 413 bar / 6,000 PSI
- Normativa SAE 100R8, ISO 3949, EU 10/2011, CGA G-7.1 2004 GRADE E, DNV-GL, MSHA
- Soluzione certificata ideale per ricarica bombole Aria Respirabile

### Main Features

- Constant pressure at 413 bar / 6,000 PSI
- SAE 100R8, ISO 3949, EU 10/2011 standards, CGA G-7.1 2004 GRADE E, DNV-GL, MSHA
- Ideal solution for Breathing Air tank filling systems

### Caratteristiche tecniche

#### Caratteristiche tecnico-costruttive:

Anima interna in polimero termoplastico idoneo per il contatto con alimenti ed aria respirabile, rinforzo con doppia treccia in fibra aramidica e esterno in poliuretano antiabrasione stabilizzato ai raggi UV e resistente all'idrolisi e ai microrganismi. Tubi microperforati per passaggio aria e gas compatibili.

Le tubazioni della serie AT8S BREATHING AIR sono state create per la conduzione di fluidi ad alta pressione per stazioni di aria compressa e per ricambi SCBA per i quali sia richiesta una materia prima dell'anima idonea per il contatto con alimenti. La tubazione non è idonea per impiego medicale, farmaceutico, gas esplosivi e alimenti contenenti alcool. Per uso con ossigeno ad alta pressione si prega di consultare le raccomandazioni di utilizzo sul nostro sito, nella sezione Supporto Tecnico: <https://www.zecspa.com/it/supporto-tecnico/Lineguidaossigeno>.

#### Temperature di utilizzo:

Da -40°C a +82°C Da -40°F a +180°F

Per aria, acqua e fluidi a base acquosa la temperatura massima di esercizio è +70°C (+158°F).

#### Pressioni d'esercizio:

Rapporto di sicurezza 1:4

#### Valore max. di vuoto:

0,93 bar; 700 mm Hg

#### Specifiche:

CGA G-7.1-2004 Grade E Breathing Air Standards, NFPA 1901. Reg. EU 10/2011 e FDA 21 CFR 177.2600.

Conformi o superiori alle norme SAE J517 sez.100R8 - ISO 3949 (ad eccezione di 1/4")

Type Approval DNV-GL. MSHA Standards.

### Technical Features

#### Technical-constructive features:

Inner core in thermoplastic polymer suitable to be in contact with food and breathing air, reinforcement in double aramid fiber braid and exterior covering in antiabrasion polyurethane stabilized against UV rays and resistant to hydrolysis and microorganisms, micro perforated for air and compatible gases. AT8S BREATHING AIR hose series have been created for the high pressure conduction of fluids for air compressor stations and for SCBA refilling requiring a raw material suitable to be used with food. These hoses are not suitable for medical and pharmaceutical use, explosive gases and food containing alcohol. For use with high pressure oxygen, please refer to the oxygen service guidelines on our website in Technical Support Area: <https://www.zecspa.com/en/technical-support/Oxygenserviceguideline>.

#### Working temperature:

from -40°C to +82°C from -40°F to +180°F.

Max. working temperature of air, water and water-based fluids is +70°C (+158°F).

#### Working pressure:

Safety ratio 1:4

#### Vacuum rating:

0.93 bar; 700 mm Hg

#### Specifications:

CGA G-7.1-2004 Grade E Breathing Air Standards. NFPA 1901 Reg. EU 10/2011, FDA 21 CFR 177.2600

Meet or exceed SAE J517 sec.100R8 – ISO 3949 (Except 1/4")

Type approval DNV-GL. MSHA Standards.

### Scheda tecnica - Data Sheet



CODE	inch	-dash	mm	DN	inch	mm	bar	psi	mm	inch	g/m	lbs/ft	FERRULE CODE
AT8S27100	3/16"	-3	4.8	5	0.413	10.5	413	6000	35	1.38	80	0.054	BP5320L8M
AT8S37100	1/4"	-4	6.4	6	0.500	12.7	413	6000	50	1.97	100	0.067	BP14MT1
AT8S57100	3/8"	-6	9.7	10	0.650	16.5	413	6000	75	2.95	149	0.100	BP38R7V
AT8S67100	1/2"	-8	13.0	12	0.866	22.0	413	6000	110	4.33	287	0.193	BP12R9R

## AT8S-FEP WATERPROOF COVER



### Caratteristiche principali

- Normativa SAE J517-100R8, ISO 3949, EU 10/2011, CGA G-7.1 2004 GRADE E
- Soluzione raccomandata per compressori Aria Respirabile ad elevate prestazioni

### Main Features

- SAE J517-100R8, ISO 3949, EU 10/2011, CGA G-7.1 2004 GRADE E
- Recommended solution on high performance Breathing Air compressors

### Caratteristiche tecniche

#### • Caratteristiche tecnico-costruttive:

Anima interna in FEP, rinforzo aramidico a doppia treccia e rivestimento esterno in poliuretano antiabrasione stabilizzato ai raggi UV e resistente all'idrolisi e ai microrganismi, microforato per aria e gas compatibili.

Le tubazioni della serie AT8S-FEP BREATHING AIR sono state create per il trasporto di fluidi ad alta pressione per stazioni di aria compressa e per ricambi SCBA per i quali sia richiesta una materia prima dell'anima idonea per il contatto con alimenti. La tubazione non è idonea per impiego medicale, farmaceutico, gas esplosivi e alimenti contenenti alcool. Per uso con ossigeno ad alta pressione si prega di consultare le raccomandazioni di utilizzo sul nostro sito, nella sezione Supporto Tecnico: <https://www.zecspa.com/it/supporto-tecnico/Lineguidaossigeno>.

#### • Temperature di utilizzo:

Da -40°C a +100°C Da -40°F a +212°F.

#### • Pressioni d'esercizio:

Rapporto di sicurezza 1:4

#### • Valore max. di vuoto:

0,93 bar; 700 mm Hg  
(pressione assoluta 13.5 psi; 27.5 inchHg)

#### • Specifiche:

Tubazioni conformi alle normative CGA G-7.1-2004 Grade E Breathing Air, NFPA 1901.

Reg. EU 10/2011, FDA 21 CFR 177.2600.

Tubazioni conformi o superiori alle norme SAE J517 – 100R8, ISO 3949.

### Technical Features

#### • Technical-constructive features:

Inner core in FEP, double braided aramidic reinforcement and outer covering in antiabrasion polyurethane stabilized against UV light and resistant to hydrolysis and microorganisms, pin-pricked for air and compatible gases.

AT8S-FEP BREATHING AIR hose series have been created for high pressure conveying of fluids for air compressor stations and for SCUBA refilling, requiring a raw material suitable to be used with food. These hoses are not suitable for medical and pharmaceutical use, explosive gases and food containing alcohol. For use with high pressure oxygen, please refer to the oxygen service guidelines on our website in Technical Support Area: <https://www.zecspa.com/en/technical-support/Oxygenserviceguideline>.

#### • Working temperature:

from -40°C to +100°C from -40°F to +212°F.

#### • Working pressure:

Safety ratio 1:4

#### • Max. vacuum value:

0.93 absolute bar; 700 mmHg  
(13.5 absolute psi; 27.5 inchHg)

#### • Specifications:

These hoses meet standard CGA G-7.1-2004 Grade E Breathing Air Standards, NFPA 1901.

Reg. EU 10/2011, FDA 21 CFR 177.2600.

Hose meets or exceeds SAE J517 – 100R8, ISO 3949 standards.

### Scheda tecnica - Data Sheet



CODE	inch	-dash	mm	DN	inch	mm	bar	psi	bar	psi	mm	inch	g/m	lbs/ft	FERRULE CODE
AT8S27100FEP	3/16"	-3	5.0	5	0.402	10.2	425	6164	1700	24656	35	1.38	87	0.0585	BP316R7



## MTHAT1 WATERPROOF COVER



### Caratteristiche principali

- Pressione da 130 a 300 bar
- Normativa SAE 100R1, FDA 21 CFR, EU 10/2011
- Soluzione anti-statica
- Per la conduzione di fluidi alimentari ad alta pressione

### Main Features

- Pressure from 130 to 300 bar
- SAE 100R1, fda 21 cfr, eu 10/2011 standards
- Anti-static solution
- Food and beverage high pressure handling solution

### Caratteristiche tecniche

• **Caratteristiche tecnico-costruttive:**  
Anima interna in polimero termoplastico idoneo per il contatto con alimenti, rinforzo con treccia in acciaio ad alta resistenza ed esterno in poliuretano antiabrasione stabilizzato ai raggi UV e resistente all'idrolisi e ai microrganismi. Tubi microperforati per passaggio aria e gas compatibili. Per uso con ossigeno ad alta pressione si prega di consultare le raccomandazioni di utilizzo sul nostro sito, nella sezione Supporto Tecnico: <https://www.zecspa.com/it/supporto-tecnico/Lineeguidaossigeno>.

• **Temperature di utilizzo:**  
Da -40°C a +82°C (da -40°F a +180°F).  
Per aria, acqua e fluidi a base acquosa la temperatura massima di esercizio è +70°C (+158°F).

• **Pressioni d'esercizio:**  
Rapporto di sicurezza 1:4

• **Valore max. di vuoto:**  
0,93 bar; 700 mm Hg

• **Specifiche:**  
Tubazioni conformi o superiori alle pressioni delle norme SAE 100R1 - EN 853 1ST, 1SN - EN 857 1SC.  
Reg. CE 1935/2004, Reg. UE 10/2011. Simulanti A, B, C e D1. Condizioni standardizzate OM4. Da non utilizzare con cibi grassi. FDA 21 CFR 177.2600. Utilizzabile con tutti i cibi fino a 65°C e con contenuto di alcool inferiore all'8%.  
D.M. 174 del 06/04/2004 utilizzo con acqua potabile.

### Technical Features

• **Technical-constructive features:**  
Inner core in thermoplastic polymer suitable to be in contact with food, reinforcement in high tensile steel braid and exterior covering in antiabrasion polyurethane stabilized against UV rays and resistant to hydrolysis and microorganisms, micro perforated for air and compatible gases. For use with high pressure oxygen, please refer to the oxygen service guidelines on our website in Technical Support Area: <https://www.zecspa.com/en/technical-support/Oxygenserviceguideline>.

• **Working temperature:**  
from -40°C to +82°C from -40°F to +180°F.  
Max. working temperature of air, water and water-based fluids is +70°C (+158°F).

• **Working pressure:**  
Safety ratio 1:4

• **Vacuum rating:**  
0,93 bar; 700 mm Hg

• **Specifications:**  
Meet or exceed pressures under SAE 100R1 - EN 853 1ST, 1SN - EN 857 1SC Standards.  
Reg. EU 1935/2004 and Reg. EU 10/2001. Simulants A, B, C and D1. Standardised testing conditions OM4. Do not use in contact with fatty food.  
FDA 21 CFR 177.2600. To use with all type of food up to 65°C and containing less than 8% alcohol.  
Italian D.M. 174 of 06/04/2004 for use in drinking water supply chain.

### Scheda tecnica - Data Sheet



CODE	inch	mm	-dash	DN	inch	mm	bar	psi	mm	inch	g/m	lbs/ft	FERRULE CODE
MTHAT137100	1/4"	6.4	-4	6	0.469	11.9	300	4350	40	1.57	170	0.114	BPI14MT1
MTHAT157100	3/8"	9.7	-6	10	0.630	16	225	3262	60	2.36	260	0.175	BPI38R7V
MTHAT167100	1/2"	13	-8	12	0.756	19.2	190	2755	75	2.95	326	0.219	BPI12R7V
MTHAT187100	3/4"	19.2	-12	19	1.003	25.5	130	1885	150	5.91	454	0.305	BPI34R7

## MTHAT2 WATERPROOF COVER



### Caratteristiche principali

- Pressione da 215 a 400 bar
- Normativa SAE 100R2, FDA 21 CFR, EU 10/2011
- Soluzione anti-statica
- Per la conduzione di fluidi alimentari ad alta pressione, O2 ed Aria Respirabile per ricarica bombole

### Main Features

- Pressure from 215 to 400 bar
- SAE 100R2, FDA 21 CFR, EU 10/2011 standards
- Anti-static solution
- Food and beverage high pressure handling solution, O2 and Breathing Air tank filling systems

### Caratteristiche tecniche

#### Caratteristiche tecnico-costruttive:

Anima interna in polimero termoplastico idoneo per il contatto con alimenti, rinforzo con doppia treccia in acciaio ad alta resistenza ed esterno in poliuretano antiabrasione stabilizzato ai raggi UV e resistente all'idrolisi e ai microrganismi. Tubi microperforati per passaggio aria e gas compatibili. Per uso con ossigeno ad alta pressione si prega di consultare le raccomandazioni di utilizzo sul nostro sito, nella sezione Supporto Tecnico: <https://www.zecspa.com/it/supporto-tecnico/Lineeguidaossigeno>.

#### Temperature di utilizzo:

Da -40°C a +82°C Da -40°F a +180°F  
Per aria, acqua e fluidi a base acquosa la temperatura massima di esercizio è +70°C (+158°F).

#### Pressioni d'esercizio:

Rapporto di sicurezza 1:4

#### Valore max. di vuoto:

0,93 bar; 700 mm Hg

#### Specifiche:

Tubazioni conformi o superiori alle pressioni della norma SAE 100R2.  
Reg. CE 1935/2004. Reg. UE 10/2011. Simulanti A, B, C e D1. Condizioni standardizzate OM4. Da non utilizzare con cibi grassi.  
FDA 21 CFR 177.2600. Utilizzabile con tutti i cibi fino a 65°C e con contenuto di alcool inferiore all'8%.  
D.M. 174 del 06/04/2004 utilizzo con acqua potabile.

### Technical Features

#### Technical-constructive features:

Inner core in thermoplastic polymer suitable to be in contact with food, reinforcement in high tensile steel braid and exterior covering in antiabrasion polyurethane stabilized against UV rays and resistant to hydrolysis and microorganisms, micro perforated for air and compatible gases. For use with high pressure oxygen, please refer to the oxygen service guidelines on our website in Technical Support Area: <https://www.zecspa.com/en/technical-support/Oxygenserviceguideline>.

#### Working temperature:

From -40°C to +82°C (-40°F to +180°F)  
Max. working temperature with air, water and fluids containing water: +70°C (+158°F).

#### Working pressure:

Safety ratio 1:4

#### Vacuum rating:

0,93 bar; 700 mm Hg

#### Specifications:

These hoses meet or exceed standards SAE 100R2 pressures. Reg. EC 1935/2004. Reg. EU 10/2011. Simulants A, B, C and D1. Standardised testing conditions OM4. Do not use in contact with fatty foods.  
FDA 21 CFR 177.2600. To use with all type of food up to 149°F and containing less than 8% alcohol.  
D.M. 174 of 06/04/2004 for use in the drinking water supply chain.

### Scheda tecnica - Data Sheet



CODE	inch	mm	-dash	DN	inch	mm	bar	psi	mm	inch	g/m	lbs/ft	FERRULE CODE
MTHAT237100	1/4"	6.4	-4	6	0.531	13.5	400	5800	40	1.57	294	0.198	BPI14MT2
MTHAT257100	3/8"	9.7	-6	10	0.669	17	330	4785	60	2.36	418	0.281	BPI38R2
MTHAT267100	1/2"	13	-8	12	0.846	21.5	275	3987	75	2.95	598	0.402	BPI12JC7
MTHAT287100	3/4"	19.2	-12	20	1.083	27.5	215	3117	150	5.91	788	0.530	BPI34JC7

# MTK-CO

## SELF-EXTINGUISHING CONDUCTIVE



### Caratteristiche principali

- Soluzione con anima conduttiva ad alta pressione
- Rivestimento autoestinguente UL94-V0
- Per la conduzione ad alta pressione di olii, polioli, solventi e fluidi a base acquosa

### Main Features

- High pressure, conductive inner core solution
- Self-extinguishing cover, according to UL94-V0
- High pressure solution for oils, polyols, solvents and water based fluids

### Caratteristiche tecniche

- **Caratteristiche tecnico-costruttive:**  
Anima interna in poliammide conduttivo, rinforzo con una treccia di fibra aramidica e una treccia in acciaio ad alta resistenza. Rivestimento esterno in poliuretano autoestinguente nero (UL 94 V0).
- **Temperature di utilizzo:**  
Da -10°C a +40°C    Da 14°F a +104°F.  
Per aria, acqua e fluidi a base acquosa la temperatura massima di esercizio è +70°C (+158°F).
- **Pressioni d'esercizio:**  
Rapporto di sicurezza 1:4
- **Valore max. di vuoto:**  
0.93 bar; 700 mm Hg

### Technical Features

- **Technical-constructive features:**  
Inner core in conductive polyamide, reinforcement in one aramidic fiber braid and one high tensile steel braid. Outer covering in black self-extinguishing polyurethane (UL 94 V0).
- **Working temperatures:**  
From -10°C to +40°C    From 14°F to +104°F.  
In case of water, or water-based fluids, max. working temperature is +70°C (+158°F).
- **Working pressure:**  
Safety factor 4:1
- **Vacuum rating:**  
0.93 bar; 700 mm Hg

### Scheda tecnica - Data Sheet



CODE	inch	-dash	mm	DN	inch	mm	bar	psi	bar	psi	mm	inch	g/m	lbs/ft	FERRULE CODE
MTK5800CO	3/8"	-6	9.5	10	0.709	18.0	425	6164	1700	24656	60	2.362	340	0.228	BPI38R9R*
MTK6800CO	1/2"	-8	13.0	12	0.866	22.0	375	5439	1500	21756	75	2.953	448	0.301	BPI12R9R*

\* Si raccomanda l'utilizzo di Raccordi ZEC tipo MULTISPIRAL.

\*We recommend the use of ZEC Fittings MULTISPIRAL.

## CO<sub>2</sub> SYSTEM WATERPROOF COVER



### Caratteristiche principali

- Pressione da 140 a 300 bar
- Omologato LR e DNV TAP00002C3
- Per sistemi antincendio con CO<sub>2</sub> a media e alta pressione in ambienti navali

### Main Features

- Pressure from 140 to 300 bar
- LR and DNV TAP00002C3 Type Approved
- For CO<sub>2</sub> medium & high pressure fire suppression systems in marine environments

### Caratteristiche tecniche

#### Caratteristiche tecnico-costruttive:

Anima interna in poliestere termoplastico, rinforzo in tessuto di poliestere / treccia d'acciaio ad alta resistenza, rivestimento esterno in poliuretano antiabrasione e resistente all'idrolisi, stabilizzato ai raggi UV e resistente ai microrganismi per applicazioni esterne, in ambienti con elevata umidità e salinità.

#### Temperature di utilizzo:

Da -40°C a +100°C Da -40°F a +212°F

Per aria, acqua e fluidi a base acquosa la temperatura massima di esercizio è +70°C (+158°F).

#### Pressioni d'esercizio:

Rapporto di sicurezza 1:4

#### Valore max. di vuoto:

0,93 bar; 700 mm Hg

#### Specifiche:

# I tubi soddisfano o superano le normative SAE 100R7, MSHA.

Δ I tubi soddisfano o superano le pressioni previste dagli standard SAE 100R1 - EN 853 1st, 1SN - EN 857 1SC - MSHA.

### Technical Features

#### Technical-constructive features:

Inner core in thermoplastic polyester, reinforcement in polyester textile / high tensile steel braid, exterior covering in antiabrasion polyurethane and resistant to hydrolysis, stabilized against UV rays and microorganisms-resistant for outdoor applications, in environments having high humidity and saline levels.

#### Working temperature:

From -40°C to +100°C From -40°F a +212°F.

Max. working temperature of air, water and water-based fluids is +70°C (158°F).

#### Working pressure:

Safety ratio 1:4

#### Vacuum rating:

0,93 bar; 700 mm Hg

#### Specifications:

# Hoses meet or exceed SAE 100R7, MSHA Standards.

Δ Hoses meet or exceed pressures under SAE 100R1 - EN 853 1st, 1SN - EN 857 1SC - MSHA Standards.

### Scheda tecnica - Data Sheet



CODE	inch	mm	-dash	DN	inch	mm	bar	psi	bar	psi	mm	inch	g/m	lbs/ft	FERRULE CODE
OL727100C02#	3/16"	4.8	-3	5	0.394	10.0	210	3045	840	12180	30	1.18	73	0.049	BP316R7
OL737100C02#	1/4"	6.4	-4	6	0.465	11.8	200	2900	800	11600	35	1.38	90	0.060	BP14R7
OL747100C02#	5/16"	8.0	-5	8	0.563	14.3	190	2755	760	11020	45	1.77	128	0.086	BP516R7V
OL767100C02#	1/2"	13.0	-8	12	0.799	20.3	140	2030	560	8120	75	2.95	219	0.147	BP12R7V
MTH137100C02Δ	1/4"	6.4	-4	6	0.469	11.9	300	4350	1200	17400	40	1.57	170	0.114	BP14MT1
MTH147100C02Δ	5/16"	8.0	-5	8	0.551	14.0	240	3480	960	13920	50	1.97	216	0.145	BP516R7V
MTH157100C02Δ	3/8"	9.7	-6	10	0.630	16.0	225	3262	900	13050	60	2.36	260	0.175	BP38R7V
MTH167100C02Δ	1/2"	13.0	-8	12	0.756	19.2	190	2755	760	11020	75	2.95	326	0.219	BP12R7V

Optional: Boccole e raccordi sono disponibili, su richiesta anche in Acciaio Inox AISI 316L.

Optional: Ferrules and fitting are available, on request, also in AISI 316L Stainless Steel.

# OL5FLPU FLEX-FLOW

## WATERPROOF COVER

FLEX-FLOW



### Caratteristiche principali

- Elevata flessibilità e resistenza al kinking
- Ideale fino a 25 bar - linee di ritorno, flussaggio, aria
- Compatibili con raccordi ad innesto rapido ZEC
- Versioni: multifunzione / non conduttivo / auto-estinguente
- Disponibile tubo singolo, binato e multitubo
- Copertura water proof, approvata MSHA

### Main Features

- High flexibility and kinking resistance
- Ideal solution up to 25 bar - return lines, flushing, air
- ZEC push-in fitting compatibility
- Versions: multi-purpose / non-conductive / self-extinguishing
- Available in single, twin and multi-line hose
- Water proof cover, MSHA approved

### Caratteristiche tecniche

#### Caratteristiche tecnico-costruttive:

Anima interna in poliuretano, rinforzo con una treccia in fibra tessile, rivestimento esterno in poliuretano antiabrasione, stabilizzato ai raggi UV, resistente all'ozono, ai microrganismi ed all'idrolisi, adatto per applicazioni all'esterno in ambienti particolarmente umidi e salini.

#### Temperature di utilizzo:

Da -30°C a +80°C Da -22°F a +176°F.

#### Pressioni d'esercizio:

Rapporto di sicurezza 1:4

#### Colori e opzioni:

Colori disponibili: nero, arancione, blu, rosso, verde, giallo e altri a richiesta. Disponibile versione tubo binato e multitubo a richiesta.

#### Specifiche:

Tubazione approvata MSHA.

#### Raccordi:

Disponibili raccordi standard a 2 pezzi con boccole a crimpare, oppure in versione "senza boccole" con raccordi ad inserimento rapido.

### Technical Features

#### Technical-constructive features:

Inner core in polyurethane, reinforcement with one textile fibre braid, outside cover in abrasion resistant polyurethane, UV-stabilized, resistant to ozone, microorganisms and hydrolysis, suitable for outdoor applications in wet and saline environments.

#### Working temperatures:

From -30°C to +80°C From -22°F to +176°F.

#### Working pressure:

Safety factor 1:4

#### Colours and options:

Available colours: black, orange, blue, red, green, yellow, and others on request. Available in single, twin and multi-line hose on request.

#### Specifications:

MSHA approved hose.

#### Fittings:

Available in 2-pieces standard fittings with crimping ferrules, or in "ferrule-less" push-in fittings version.

### Scheda tecnica - Data Sheet



CODE	inch	-dash	mm	DN	inch	mm	bar	psi	mm	inch	g/m	lbs/ft	FERRULE CODE
OL53#00*FLPU	1/4"	-4	6.3	6	0.441	11.2	25	363	30	1.18	75	0.050	BP516PTFEIP
OL55#00*FLPU	3/8"	-6	9.5	10	0.590	15.0	25	363	50	1.97	119	0.080	BP38PTFEIC
OL56#00*FLPU	1/2"	-8	12.7	12	0.752	19.1	20	290	70	2.76	181	0.122	BP12PTFEIC
OL558#00*FLPU	5/8"	-10	16.0	16	0.905	23.0	20	290	75	2.95	238	0.160	BP58PTFEIC
OL58#00*FLPU	3/4"	-12	19.0	20	1.024	26.0	20	290	110	4.33	283	0.190	BP34PTFEIC

#### Versioni disponibili:

- Multitubo #=7 standard NERO (\*=0)
- Non conduttivo #=7 standard ARANCIO (\*=1)
- Autoestinguente #=8 standard NERO (\*=0)

#### Available versions:

- Multipurpose #=7 standard BLACK (\*=0)
- Non conductive #=7 standard ORANGE (\*=1)
- Self-extinguishing #=8 standard BLACK (\*=0)

## Le soluzioni ZEC per applicazioni ad alta temperatura

ZEC offre una gamma di tubi termoplastici progettati per la conduzione di olii idraulici, sostanze chimiche corrosive, vernici, vapore e fluidi alimentari ad alte temperature.

### CARATTERISTICHE TECNICHE

- Elevata resistenza chimica
- Elevata temperatura

### APPLICAZIONI

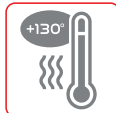

ALTA  
TEMPERATURA  
+130°C

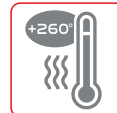

ALTA  
TEMPERATURA  
+260°C

### CERTIFICAZIONI

Tutti i tubi ZEC sono prodotti in conformità al **Regolamento Europeo CE 1907/2006 "REACH"** e alla **Direttiva Europea UE 65/2011 "RoHS"**.

### QUALITÀ

Il sistema di qualità certificato **ISO 9001:2015 ZEC** assicura un controllo continuo e costante del processo produttivo, garantendo il rispetto delle buone pratiche di fabbricazione.

## ZEC Solutions for High Temperature Applications

ZEC offers a range of thermoplastic hoses designed for the conduction of hydraulic oils, corrosive chemical agents, steam and food at high temperature.

### TECHNICAL FEATURES

- High chemical resistance
- High temperature

### APPLICATIONS

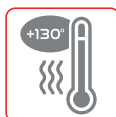

HIGH  
TEMPERATURE  
+130°C

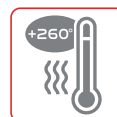

HIGH  
TEMPERATURE  
+260°C

### CERTIFICATIONS

All ZEC hoses are manufactured in conformity to **European Regulation EU 1907/2006 "REACH"** and **European Directive EU 2011/65 "RoHS"**.

### QUALITY

The certified **ISO 9001:2015 ZEC** quality system ensures a continuous and constant control of the production process, guaranteeing compliance with Good Manufacturing Practices.

*High Temperature*



## MT1HT-PTFE OILPROOF COVER



### Caratteristiche principali

- Anima interna in PTFE idoneo per il contatto con gli alimenti
- Normativa SAE 100R1, EN 853 1ST, 1SN - EN 857 1SC, MSHA
- Per la conduzione ad alta pressione e alta temperatura di olii, polioli, solventi ma anche fluidi alimentari

### Main Features

- Inner core in PTFE suitable for contact with food
- SAE 100R1 standard, EN 853 1ST, 1SN - EN 857 1SC, MSHA
- High pressure and high temperature oils, polyols, solvents, but also food and beverage

### Caratteristiche tecniche

#### Caratteristiche tecnico-costruttive:

Anima interna in PTFE idoneo per il contatto con alimenti, rinforzo con una treccia in acciaio ad alta resistenza e rivestimento esterno in poliuretano antiabrasione a richiesta microforato per passaggio aria e gas compatibili.

#### Temperature di utilizzo:

Da -40°C a +135°C (da -40°F a +275°F).

#### Pressioni d'esercizio:

Rapporto di sicurezza 1:4

#### Valore max. di vuoto:

0.93 bar; 700 mm Hg

#### Specifiche:

Tubazioni conformi o superiori alle pressioni delle norme SAE 100R1 - EN 853 1ST, 1SN - EN 857 1SC.

Reg. CE 1935/2004. Reg. UE 10/2011. Simulanti A, B, C e D1. Condizioni standardizzate OM6. Simulante D2 condizioni di contatto OM7.

D.M. 174 del 06/04/2004 utilizzo con acqua potabile.

FDA 21 CFR 177.1550.

### Technical Features

#### Technical-constructive features:

Inner core in PTFE suitable to be in contact with food, reinforcement in high tensile steel braid and external cover in antiabrasion polyurethane, pin-pricked on request for the conduction of air and compatible gases.

#### Temperature range:

From -40°C to +135°C (-40°F to +275°F).

#### Working pressure:

Safety ratio 1:4

#### Vacuum Rating:

0.93 bar; 700 mm Hg

#### Specifications:

These hoses meet or exceed standards SAE 100R1, EN 853 1ST, 1SN - EN 857 1SC pressure.

Reg. EC 1935/2004, Reg. EU 10/2011. Simulants A, B, C and D1 with standardised testing condition OM6. Simulant D2 testing condition OM7.

D.M. 174 of 06/04/2004 for use in the drinking water supply chain.

FDA 21 CFR 177.1550.

### Scheda tecnica - Data Sheet



CODE	inch	mm	-dash	DN	inch	mm	bar	psi	mm	inch	g/m	lbs/ft	FERRULE CODE
MT110000HT	1/8"	3.5	-2	3	0.295	7.5	375	5437	30	1.18	76	0.051	BPI18MT1
MT120000HT	3/16"	4.8	-3	5	0.394	10	350	5075	30	1.18	133	0.089	BPI316R7
MT130000HT	1/4"	6.4	-4	6	0.469	11.9	300	4350	40	1.57	165	0.111	BPI14MT1
MT140000HT	5/16"	8	-5	8	0.551	14	240	3480	50	1.97	205	0.138	BPI516R7V
MT150000HT	3/8"	9.7	-6	10	0.630	16	225	3262	60	2.36	253	0.170	BPI38R7V
MT160000HT	1/2"	13	-8	12	0.756	19.2	190	2755	75	2.95	314	0.211	BPI12R7V
MT170000HT	5/8"	16.3	-10	16	0.917	23.3	150	2175	110	4.33	406	0.273	BPI58R7V
MT180000HT	3/4"	19.2	-12	19	1.003	25.5	130	1885	150	5.91	447	0.300	BPI34R7V
MT190000HT	1"	25.6	-16	25	1.280	32.5	105	1520	185	7.28	590	0.396	BPI1R7V
MT1100000HT	1 1/4"	32	-20	32	1.574	40	70	1015	290	11.41	842	0.566	BPI114JC7



## PTFEIP

AISI 304 STAINLESS STEEL



### Caratteristiche principali

- Pressione da 65 a 200 bar
- Piccolo spessore
- Temperatura di utilizzo fino a 260°C

### Main Features

- Pressure from 65 to 200 bar
- Small thickness
- Working temperature up to 260°C

### Caratteristiche tecniche

- **Caratteristiche tecnico-costruttive:**  
Anima interna in PTFE e rinforzo con una treccia in acciaio Inox AISI 304.
- **Temperature di utilizzo:**  
Da -60°C a +260°C Da -76°F a +500°F
- **Specifiche:**  
Reg. UE 1935/2004 e Reg. UE 10/2011. Simulanti A, B, C e D1. Condizioni standardizzate OM6. Simulante D2 condizioni standardizzate OM7.  
FDA 21 CFR 177.1550  
D.M. 174 del 06/04/2004 per utilizzo con acqua potabile.

### Technical Features

- **Technical-constructive features:**  
Inner core in PTFE and reinforcement braid in AISI 304 stainless steel.
- **Working temperature:**  
From -60°C to +260°C from -76°F to +500°F
- **Specifications:**  
Reg. EU 1935/2004, Reg. EU 10/2011. Simulants A, B, C and D1. Standardised testing conditions OM6. Simulant D2 testing conditions OM7.  
FDA 21 CFR 177.1550  
Italian D.M. 174 of 06/04/2004 for use in drinking water supply chain.

### Coefficiente di correzione della pressione di scoppio in funzione della temperatura

Pressure correction factor according to temperature

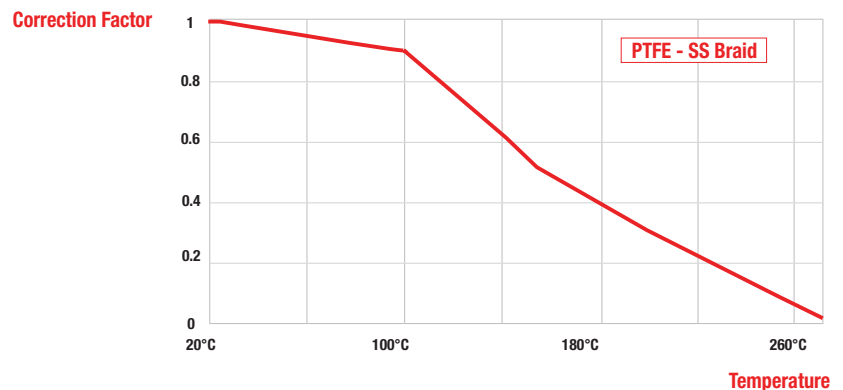

### Scheda tecnica - Data Sheet



CODE	inch	mm	-dash	DN	inch	mm	mm	inch	bar	psi	mm	inch	g/m	lbs/ft	FERRULE CODE
PTFE316IP	3/16"	4.8	-3	5	0.29	7.4	0.7	0.027	200	2900	35	1.37	69	0.046	BPI316PTFEIP
PTFE14IP	1/4"	6.35	-4	6	0.34	8.9	0.7	0.027	175	2540	45	1.77	87	0.058	BPI14PTFEIP
PTFE516IP	5/16"	8	-5	8	0.43	10.9	0.7	0.027	150	2170	50	1.96	127	0.085	BPI516PTFEIP
PTFE38IP	3/8"	9.5	-6	10	0.47	12.4	0.7	0.027	135	1960	55	2.16	145	0.097	BPI38PTFEIP
PTFE12IP	1/2"	12.7	-8	12	0.61	15.7	0.7	0.027	120	1740	70	2.75	212	0.142	BPI12PTFEIP
PTFE58IP	5/8"	16	-10	16	0.75	19.1	0.7	0.027	100	1450	130	5.11	260	0.175	BPI58PTFEIP
PTFE34IP	3/4"	19	-12	19	0.87	22.2	0.8	0.031	90	1310	190	7.48	321	0.216	BPI34PTFEIP
PTFE1IP	1"	25.4	-16	25	1.14	29.3	0.8	0.031	65	940	270	10.62	450	0.302	BPI1PTFEIP

## PTFEIM AISI 304 STAINLESS STEEL



### Caratteristiche principali

- Pressione da 65 a 275 bar
- Medio spessore
- Temperatura di utilizzo fino a 260°C

### Caratteristiche tecniche

- **Caratteristiche tecnico-costruttive:**  
Anima interna in PTFE e rinforzo con una treccia in acciaio Inox AISI 304.
- **Temperature di utilizzo:**  
Da -60°C a +260°C Da -76°F a +500°F
- **Specifiche:**  
Reg. UE 1935/2004 e Reg. UE 10/2011. Simulanti A, B, C e D1. Condizioni standardizzate OM6. Simulante D2 condizioni standardizzate OM7.  
FDA 21 CFR 177.1550  
D.M. 174 del 06/04/2004 per utilizzo con acqua potabile.

### Coefficiente di correzione della pressione di scoppio in funzione della temperatura

### Pressure correction factor according to temperature

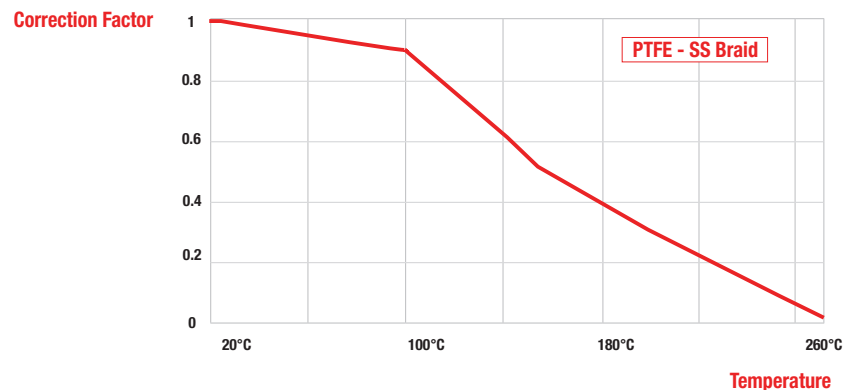

### Scheda tecnica - Data Sheet



CODE	inch	mm	-dash	DN	inch	mm	mm	inch	bar	psi	mm	inch	g/m	lbs/ft	FERRULE CODE
PTFE18IM	1/8"	3.2	-2	3	0.25	6.5	1.0	0.039	275	3990	25	0.98	70	0.047	BP180L5
PTFE316IM	3/16"	4.8	-3	5	0.30	7.8	0.9	0.035	200	2900	35	1.37	90	0.060	BP316PTFEIP
PTFE14IM	1/4"	6.35	-4	6	0.37	9.4	0.9	0.035	175	2540	45	1.77	110	0.074	BP14PTFEIP
PTFE516IM	5/16"	8.0	-5	8	0.44	11.3	0.9	0.035	150	2170	50	1.96	150	0.101	BP516PTFEIP
PTFE38IM	3/8"	9.5	-6	10	0.50	12.8	0.9	0.035	135	1960	55	2.16	172	0.116	BP38PTFEIP
PTFE12IM	1/2"	12.7	-8	12	0.63	16.2	0.9	0.035	120	1740	70	2.75	244	0.164	BP12PTFEIP
PTFE58IM	5/8"	16.0	-10	16	0.76	19.5	0.9	0.035	100	1450	130	5.11	300	0.202	BP58PTFEIP
PTFE34IM	3/4"	19.0	-12	19	0.88	22.6	1.0	0.039	90	1310	190	7.48	367	0.247	BP34PTFEIP
PTFE1IM	1"	25.4	-16	25	1.17	29.7	1.1	0.043	65	940	270	10.62	503	0.338	BP1PTFEIP

## PTFEIG AISI 304 STAINLESS STEEL



### Caratteristiche principali

- Pressione da 65 a 275 bar
- Grosso spessore
- Temperatura di utilizzo fino a 260°C

### Main Features

- Pressure from 65 to 275 bar
- Large thickness
- Working temperature up to 260°C

### Caratteristiche tecniche

- **Caratteristiche tecnico-costruttive:**  
Anima interna in PTFE e rinforzo con una treccia in acciaio Inox AISI 304.
- **Temperature di utilizzo:**  
Da -60°C a +260°C Da -76°F a +500°F
- **Specifiche:**  
Reg. UE 1935/2004 e Reg. UE 10/2011. Simulanti A, B, C e D1. Condizioni standardizzate OM6. Simulante D2 condizioni standardizzate OM7.  
FDA 21 CFR 177.1550  
D.M. 174 del 06/04/2004 per utilizzo con acqua potabile.

### Technical Features

- **Technical-constructive features:**  
Inner core in PTFE and reinforcement braid in AISI 304 stainless steel.
- **Working temperature:**  
From -60°C to +260°C from -76°F to +500°F
- **Specifications:**  
Reg. EU 1935/2004, Reg. EU 10/2011. Simulants A, B, C and D1. Standardised testing conditions OM6. Simulant D2 testing conditions OM7.  
FDA 21 CFR 177.1550  
Italian D.M. 174 of 06/04/2004 for use in drinking water supply chain.

### Coefficiente di correzione della pressione di scoppio in funzione della temperatura

#### Pressure correction factor according to temperature

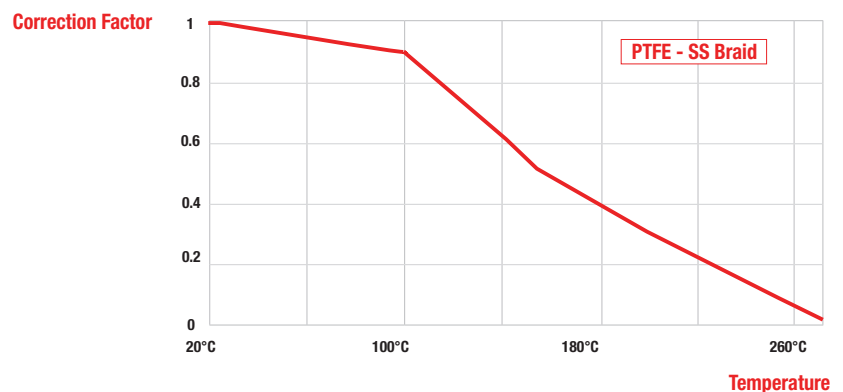

### Scheda tecnica - Data Sheet



CODE	inch	mm	-dash	DN	inch	mm	mm	inch	bar	psi	mm	inch	g/m	lbs/ft	FERRULE CODE
PTFE18IG	1/8"	3.2	-2	3	0.26	6.7	1.1	0.043	275	3990	25	0.98	85	0.057	BP180L5
PTFE316IG	3/16"	4.8	-3	4	0.34	8.6	1.2	0.047	200	2900	50	1.37	105	0.071	BP316PTFEIP
PTFE14IG	1/4"	6.35	-4	6	0.38	9.9	1.2	0.047	175	2540	100	3.93	126	0.085	BP14PTFEIP
PTFE516IG	5/16"	8.0	-5	8	0.47	12.0	1.2	0.047	150	2170	120	4.72	172	0.116	BP516PTFEIP
PTFE38IG	3/8"	9.5	-6	10	0.52	13.4	1.2	0.047	135	1960	130	5.11	207	0.139	BP38PTFEIP
PTFE12IG	1/2"	12.7	-8	12	0.65	16.7	1.2	0.047	120	1740	160	6.29	293	0.197	BP12PTFEIP
PTFE58IG	5/8"	16.0	-10	16	0.79	20.1	1.3	0.051	100	1450	190	7.48	360	0.242	BP58PTFEIP
PTFE34IG	3/4"	19.0	-12	19	0.92	23.4	1.3	0.051	90	1310	200	9.00	423	0.284	BP34PTFEIP
PTFE1IG	1"	25.4	-16	25	1.19	30.3	1.4	0.055	65	940	310	12.20	640	0.430	BP1PTFEIP

## PTFEI2T AISI 304 STAINLESS STEEL



### Caratteristiche principali

- Pressione da 150 a 365 bar
- Temperatura di utilizzo fino a 260°C

### Main Features

- Pressure from 150 to 365 bar
- Working temperature up to 260°C

### Caratteristiche tecniche

- **Caratteristiche tecnico-costruttive:**  
Anima interna in PTFE con rinforzo in doppia treccia in acciaio INOX AISI 304.
- **Temperature di utilizzo:**  
Da -60°C a +260°C Da -76°F a +500°F
- **Specifiche:**  
Reg. UE 1935/2004 e Reg. UE 10/2011. Simulanti A, B, C e D1. Condizioni standardizzate OM6. Simulante D2 condizioni standardizzate OM7.  
FDA 21 CFR 177.1550  
D.M. 174 del 06/04/2004 per utilizzo con acqua potabile.

### Technical Features

- **Technical-constructive features:**  
Inner core in PTFE with double AISI 304 stainless steel reinforcement braid.
- **Working temperature:**  
From -60°C to +260°C from -76°F to +500°F
- **Specifications:**  
Reg. EU 1935/2004, Reg. EU 10/2011. Simulants A, B, C and D1. Standardised testing conditions OM6. Simulant D2 testing conditions OM7.  
FDA 21 CFR 177.1550  
Italian D.M. 174 of 06/04/2004 for use in drinking water supply chain.

### Coefficiente di correzione della pressione di scoppio in funzione della temperatura

#### Pressure correction factor according to temperature

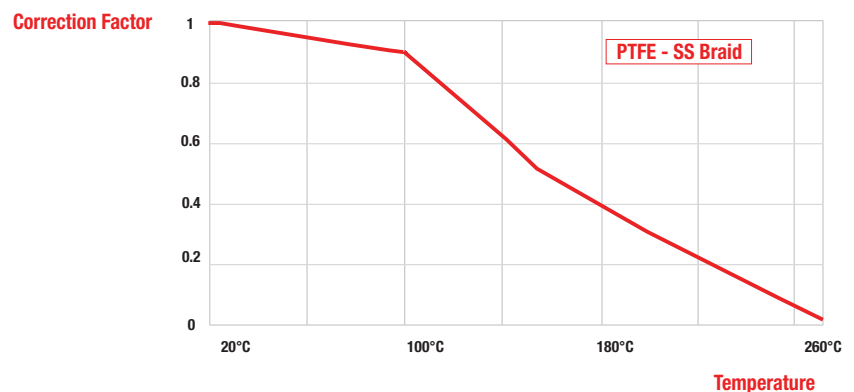

### Scheda tecnica - Data Sheet



CODE	inch	mm	-dash	DN	inch	mm	mm	inch	bar	psi	mm	inch	g/m	lbs/ft	FERRULE CODE
PTFE316I2T	3/16"	4.8	-3	5	0.354	9	0.9	0.035	365	5290	30	1.18	130	0.087	BP316R7
PTFE14I2T	1/4"	6.5	-4	6	0.425	10.8	0.9	0.035	365	5290	35	1.38	170	0.114	BP14PTFEI2T
PTFE516I2T	5/16"	8	-5	8	0.504	12.8	0.9	0.035	300	4350	40	1.57	235	0.158	BP5160L5
PTFE38I2T	3/8"	9.7	-6	10	0.567	14.4	0.9	0.035	285	4130	50	1.97	260	0.175	BP38PTFEI2T
PTFE12I2T	1/2"	12.8	-8	12	0.697	17.7	0.9	0.035	250	3620	70	2.76	390	0.262	BP12PTFEI2T
PTFE58I2T	5/8"	16	-10	16	0.827	21	0.9	0.035	235	3400	110	4.33	490	0.329	BP58R1
PTFE34I2T	3/4"	19	-12	19	0.953	24.2	1.0	0.039	200	2900	180	7.09	630	0.423	BP34R7V
PTFE1I2T	1"	25.4	-16	25	1.244	31.6	1.1	0.043	150	2170	240	9.45	730	0.491	BP1R7

## PTFEIC

AISI 304 STAINLESS STEEL



### Caratteristiche principali

- Pressione d'esercizio da 36 a 120 bar
- Temperatura di utilizzo fino a 260°C

### Main Features

- Working pressure from 36 to 120 bar
- Working temperature up to 260°C

### Caratteristiche tecniche

• **Caratteristiche tecnico-costruttive:**  
Anima interna in PTFE corrugato e rinforzo con una treccia in acciaio Inox AISI 304.

• **Temperature di utilizzo:**  
Da -60°C a +260°C Da -76°F a +500°F

• **Specifiche:**  
Reg. UE 1935/2004 e Reg. UE 10/2011. Simulanti A, B, C e D1. Condizioni standardizzate OM6. Simulante D2 condizioni standardizzate OM7.  
FDA 21 CFR 177.1550  
D.M. 174 del 06/04/2004 per utilizzo con acqua potabile.

### Technical Features

• **Technical-constructive features:**  
Inner core in corrugated PTFE and reinforcement braid in AISI 304 stainless steel.

• **Working temperature:**  
From -60°C to +260°C from -76°F to +500°F

• **Specifications:**  
Reg. EU 1935/2004, Reg. EU 10/2011. Simulants A, B, C and D1. Standardised testing conditions OM6. Simulant D2 testing conditions OM7.  
FDA 21 CFR 177.1550  
Italian D.M. 174 of 06/04/2004 for use in drinking water supply chain.

### Coefficiente di correzione della pressione di scoppio in funzione della temperatura

#### Pressure correction factor according to temperature

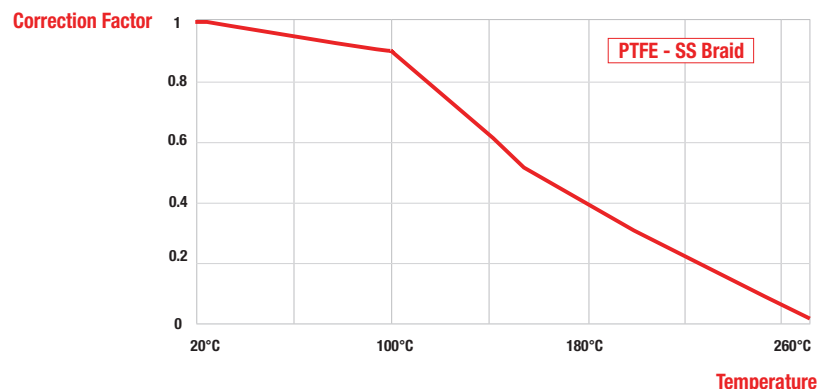

### Scheda tecnica - Data Sheet



CODE	inch	mm		-dash	DN	mm		bar	psi	mm	inch	g/m	lbs/ft	FERRULE CODE
		min.	max.			min.	max.							
PTFE38IC	3/8"	9.2	10.2	-6	10	15	16.2	120	1740	30	1.18	208	0.140	BPI38PTEFEIC
PTFE12IC	1/2"	12.2	13.2	-8	12	17.3	18.9	110	1595	40	1.57	265	0.178	BPI12PTEFEIC
PTFE58IC	5/8"	15.5	16.5	-10	16	21.5	22.9	80	1160	50	1.96	325	0.218	BPI58PTEFEIC
PTFE534IC	3/4"	18.4	19.7	-12	19	25.3	27.5	70	1015	80	3.14	387	0.260	BPI34PTEFEIC
PTFE11C	1"	24.5	26.3	-16	25	31.7	34.3	50	725	100	3.93	545	0.366	BP11PTEFEIC
PTFE114IC	1" 1/4	31	33	-20	32	39	42	45	652	120	4.72	740	0.497	BP114PTEFEIC
PTFE112IC	1" 1/2	36.6	39.4	-24	38	44.8	49.2	40	580	140	5.51	860	0.578	BP112PTEFEIC
PTFE2IC	2"	49.3	52.7	-32	51	57.7	63.6	36	522	175	6.88	1180	0.793	BP12PTEFEIC

## TICI

CORRUGATO AISI 321 - INOX AISI 304

AISI 321 CORRUGATED - AISI 304 STAINLESS STEEL



### Caratteristiche principali

- Interno in acciaio inox corrugato AISI 321
- Rinforzo con treccia metallica inox AISI 304
- Pressione da 8 a 100 bar
- Temperatura di utilizzo fino a 600°C

### Main Features

- Inner core in AISI 321 corrugated stainless steel
- AISI 304 stainless steel reinforcement braid
- Pressure from 8 to 100 bar
- Working temperature up to 600°C

### Caratteristiche tecniche

- **Caratteristiche tecnico-costruttive:**  
Anima interna metallo corrugato Inox AISI 321 e rinforzo con una treccia in metallo Inox AISI 304.
- **Temperature di utilizzo:**  
Da -200°C a +600°C Da -328°F a +1112°F

### Technical Features

- **Technical-constructive features:**  
Inner core in AISI 321 corrugated stainless metal and AISI 304 stainless metal braid reinforcement.
- **Working temperature:**  
From -200°C to +600°C from -328°F to +1112°F

### Coefficiente di correzione della pressione di scoppio in funzione della temperatura

#### Pressure correction factor according to temperature

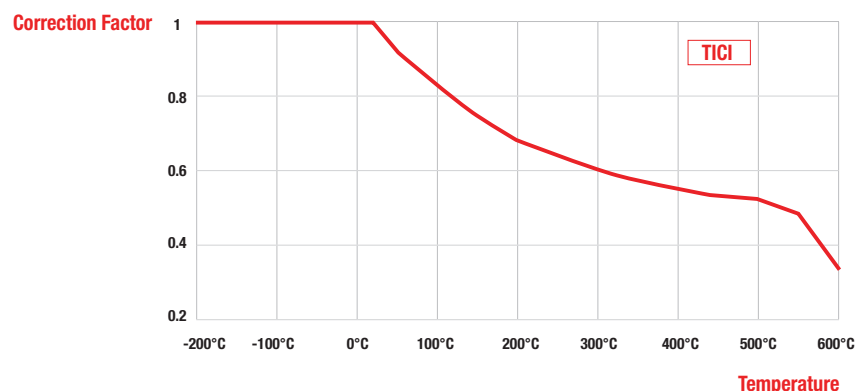

### Scheda tecnica - Data Sheet



Temperature



CODE	inch bitola	mm		DN	mm		mm	bar	mm	g/m
		min.	max.		min.	max.				
TICI38	3/8"	9.8	10.4	10	14.6	16.6	0.15	100	38	217
TICI12	1/2"	12	12.6	12	17.3	19.3	0.15	75	45	224
TICI58	5/8"	16	16.6	16	22.8	24.8	0.2	65	58	400
TICI34	3/4"	20	20.6	19	27.4	29.8	0.2	58	70	491
TICI1	1"	25.1	25.7	25	33	35.6	0.2	55	85	747
TICI114	1"1/4	34	34.6	32	41.5	44.5	0.22	50	105	892
TICI112	1"1/2	39.6	40.4	38	49.8	54.2	0.25	40	130	1392
TICI2	2"	50	51	51	62	64.6	0.25	30	160	1652
TICI212	2"1/2	65	67		77	83	0.3	24	175	2190
TICI3	3"	75.5	78.5		91	97	0.3	18	175	2590
TICI4	4"	100.5	105.8		117.5	123.5	0.4	16	250	3860
TICI5	5"	122.5	127.5		149	155	0.4	12	318	5930
TICI6	6"	148.5	153.5		178	184	0.4	10	353	6440
TICI8	8"	195	200		228	234	0.5	8	456	9900

*High Temperature*

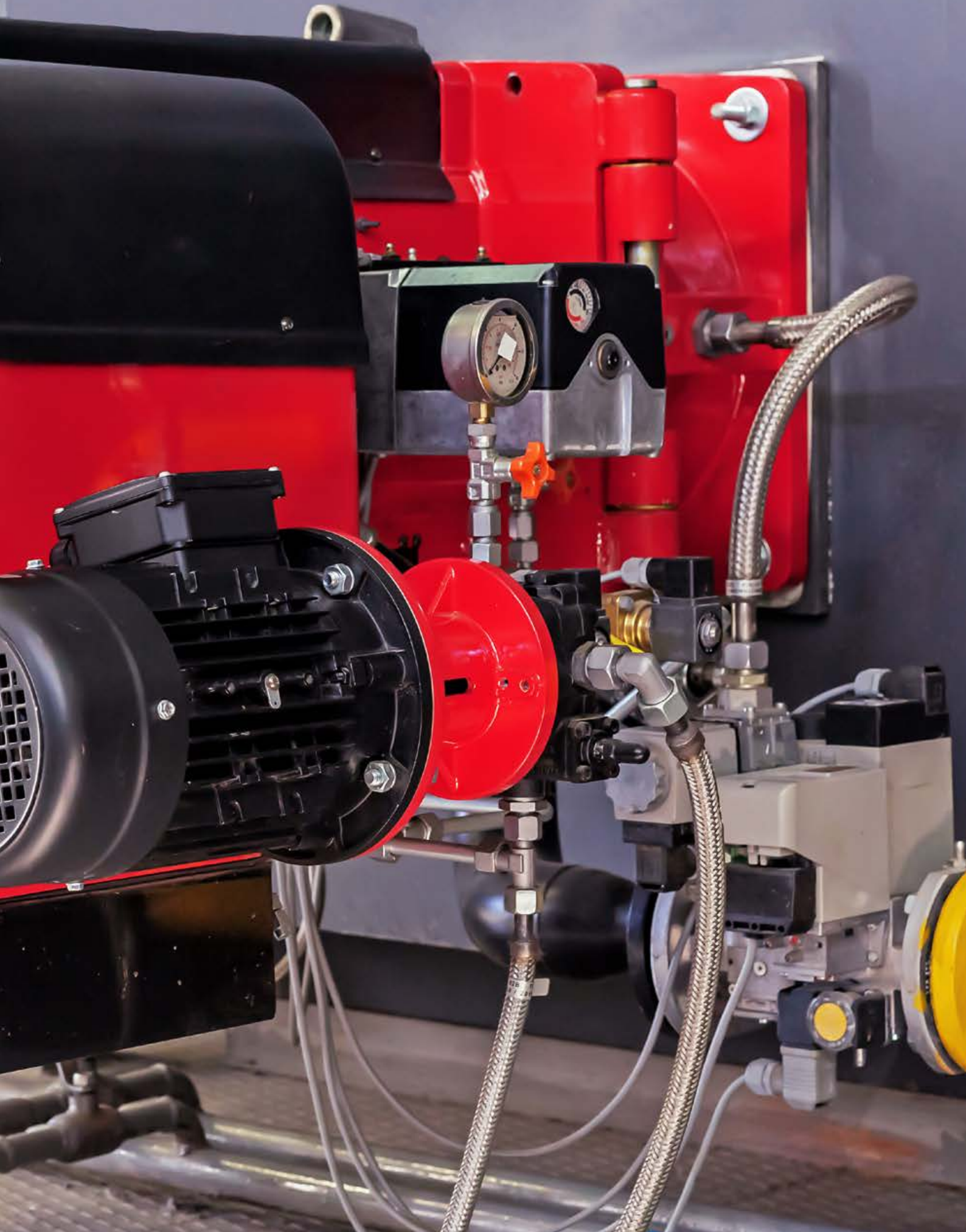

## ACCESSORI

### SPIRALI DI PROTEZIONE / PROTECTION SPIRALS



#### Specifiche tecniche:

- Spirale realizzata in polietilene ad alta densità e pratica rapida, semplice nel montaggio.
- Indicate per la protezione o il contenimento di uno o più tubi.
- Buona resistenza all'abrasione ed ai raggi UV.

#### Temperatura di esercizio:

- Da -50°C a +100°C
- Da -58°F a +212°F

#### Proprietà del materiale

La materia prima di fabbricazione delle spirali GS, deriva da un particolare processo di estrusione del Polietilene. Questo prodotto presenta caratteristiche di elevata resistenza alla rottura (ERS) e risulta conforme ad AS20170 (Australian Standard), lo stesso che garantisce l'alimentarietà di questo prodotto. Inoltre è garantita la compatibilità chimica con la maggior parte di Oli, Polioli, emulsioni e solventi.

### Accessorio per montaggio spirali / Assembly Kit



### Confezione / Packs



#### Technical features:

- The spiral is made of high-density polyethylene that is practical, quick and simple to fit.
- Suitable for the protection or containment of one or more hoses.
- Good UV and abrasion resistance.

#### Working temperature:

- From -50°C to +100°C
- From -58°F to +212°F

#### Material Properties

The raw material from which GS Protection Spiral is produced, is manufactured from high molecular weight extrusion grade polyethylene. The product exhibits extremely good environmental stress crack resistance (ERS) and conforms with the Australian Standard AS2070 – plastic material for food contact use. Moreover, chemical compatibility is granted with most of Oils, Polyols, Emulsions and solvents, thanks to the specific compound.



Codice articolo Article Code	Diametro Interno Internal Diameter	Diametro Esterno Outside Diameter	Spessore medio Wall Thickness	Larghezza bandella Strip width	Peso Weight	Diametri dei tubi Hose diameter range	Pezatura Length
	mm	mm	mm	mm	g/m	mm	m
GS128	9.5	12	1.7	10	46	10÷17	50
GS1612	12.5	16	1.8	12	76	13÷22	50
GS2016	16	20	1.8	14.5	86	16÷27	50
GS2520	21	25	2	21	112	21÷35	50
GS3227	27	32	2	24	177	27÷44	50
GS4036	34	40	2.5	30	217	34÷55	50
GS5044	44	50	3	35	278	44÷70	50
GS6356	55	63	3.5	40	588	55÷87	20
GS7567	66	75	3.4	40	813	67÷103	20
GS9080	79	90	5	45	1033	80÷122	20
GS110100	99	110	5.5	55	1200	100÷152	12
GS125114	114	125	5.6	55	1638	115÷174	12
GS140129	129	140	5.6	55	1807	130÷196	8
GS160148	148	160	6	60	2031	150÷224	6



## ACCESSORIES

### GUAINE TESSILI DI PROTEZIONE GT / GT TEXTILE PROTECTION SHEATHS

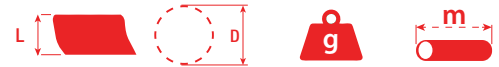

Codice articolo Article Code	Larghezza Width	Diametro Diameter	Peso Weight	Pezatura Length
	mm	mm	g/m	mt
GT35	35	20	27	100
GT40	40	22	32	100
GT45	45	25	34	100
GT50	50	28	38	100
GT55	55	32	42	100
GT60	60	35	45	100
GT65	65	38	48	100
GT80	80	45	60	100
GT90	90	50	65	100
GT120	120	70	96	100
GT150	150	90	112	100

COLORE: ■ NERO\* standard.

Altri colori disponibili su richiesta\*

■ R = Rosso ■ G = Giallo  
■ B = Blu ■ V = Verde

OPZIONI\*:

- Marcatura personalizzata
- Certificazione MSHA IC332-08

\*quantitativi minimi richiesti

COLOUR: ■ BLACK\* standard.

Other colours available on request\*

■ R = Red ■ G = Yellow  
■ B = Blue ■ V = Green

OPTIONS\*:

- Customized branding
- MSHA IC332-08 certification

\*minimum order quantities required

#### Caratteristiche Tecniche:

- adatte per la protezione o il raggruppamento di uno o più tubi
- schermatura contro i getti d'olio e contenimento dell'olio secondo ISO 3457
- realizzate in fibra di poliestere ad alta tenacità
- ottima resistenza all'abrasione e alle sollecitazioni meccaniche
- ottima resistenza al calore e bassa conducibilità termica
- adatte per applicazioni in esterno grazie all'ottima resistenza ai raggi UV e agli agenti climatici
- chimicamente compatibili con una vasta gamma di oli, prodotti organici e solventi

#### Temperature di esercizio:

- Da -40°C a +100°C
- Da -40°F a +212°F

#### Technical Features:

- suitable for protection or bundling of one or more hoses
- burst shielding against oil jets and oil containment according to ISO 3457
- made of high-tenacity polyester fiber
- excellent resistance against abrasion and mechanical stress
- excellent heat resistance and low thermal conductivity
- suitable for outdoor applications thanks to excellent resistance against UV rays and climatic agents
- chemically compatible with a huge range of oils and organic products and solvents

#### Working Temperature:

- From -40°C to +100°C
- From -40°F to +212°F



## ACCESSORI

### GUAINE DI PROTEZIONE IN FIBRA DI VETRO SILICONATE / SILICONE GLASS FIBER PROTECTION SHEATHS



Codice articolo Article Code	Ø Interno / Inside (mm)	Spessore Silicone Thickness (Min.) (mm)	Lunghezza rotoli / Rolls Length (m)
GFVS12	12	1	15
GFVS15	15	1	15
GFVS20	20	1	15
GFVS25	25	1	15
GFVS30	30	1	15
GFVS38	38	1	15
GFVS40	40	1	15
GFVS45	45	1	15
GFVS50	50	1	15
GFVS60	60	1	15
GFVS65	65	1	15

Guaina in treccia di fibra di vetro con rivestimento esterno di silicone rosso.

*Glass fiber braid sheath with red silicone exterior covering.*

**Temperatura di esercizio:**

- Da -40°C a +350°C
- Da -40°F a +662°F

**Working Temperature:**

- From -40°C to +350°C
- from -40°F to +662°F

### GUAINE DI PROTEZIONE IN PVC NORMALI E SPESSORATE / NORMAL AND THICKENED PVC PROTECTION SHEATHS



Codice articolo / Article Code		Ø Interno / Inside (mm)	Spessore / Thickness (mm)	Peso / Weight (g/m)	Bobine / Reels (m)
Normale / Normal	Spessore / Thickness				
GPVC10	---	10	0.5	26	150
GPVC16	---	16	0.5	39	100
GPVC18	---	18	0.5	52	100
GPVC20	---	20	0.6	58	100
---	GPVCS20	20	1.5	122.5	100
GPVC22	---	22	0.6	63	100
---	GPVCS23	23	1.5	140	100
GPVC25	---	25	0.6	72	100
---	GPVCS25	25	1.5	151	100
---	GPVCS27	27	1.5	164	100
GPVC28	---	28	0.6	82	100
GPVC30	---	30	0.6	87	100
---	GPVCS30	30	1.5	180	100
---	GPVCS32	32	1.5	191	50
GPVC33	---	33	0.7	104	50
---	GPVCS33	33	1.5	197	50
GPVC38	---	38	0.7	135	50
---	GPVCS38	38	1.5	225	50
GPVC40	---	40	0.7	141	50
---	GPVCS40	40	1.5	241	50
GPVC45	---	45	0.7	144	50
---	GPVCS48	48	1.5	282	50
GPVC50	---	50	0.7	167	50
GPVC55	---	55	0.7	184	50

**Temperatura di esercizio:**

- Da -15°C a +70°C
- Da +5°F a +158°F

**Working Temperature:**

- From -15°C to +70°C
- From +5°F to +158°F

## ACCESSORIES

### ACCESSORIO PER MONTAGGIO SPIRALI DI PROTEZIONE / ACCESSORY FOR MOUNTING PROTECTION SPIRALS



**Descrizione:**

Pratico attrezzo per il montaggio di SPIRALI di PROTEZIONE sui tubi termoplastici ZEC. Fino al Ø 35 mm con GS3227.

Da utilizzarsi con l'ausilio di un supporto stabile per il fissaggio dell'attrezzo stesso e di un avvitatore per la rotazione della tubazione.

**Caratteristiche Tecniche:**

Dimensioni: H x L x P 110x125x100 mm

Peso: 0.90 Kg

Codice: GSWPV1

**Description:**

Practical tool for mounting PROTECTION SPIRALS on ZEC thermoplastic tubes. Up to Ø 35 mm with GS3227.

To be used with the aid of a stable support to secure the tool and an electric screwdriver to rotate the tubing.

**Technical Features:**

Sizes: H x L x D 110x125x100 mm

Weight: 0.90 Kg

Part nr.: GSWPV1

### PROTEZIONI PER TUBI HBR - HOSE BEND RESTRICTORS / PROTECTIONS FOR HBR HOSES - HOSE BEND RESTRICTORS

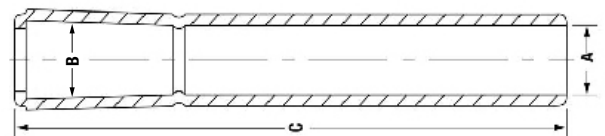

Codice / Code	A (mm)	B (mm)	C (mm)	Tubo / Hose
HBR10	13.0	15.0	135	1/4"
HBR20	15.5	16.5	135	1/4"M - 5/16"
HBR40	17.0	18.3	163	3/8"
HBR100	22.5	24.6	197	1/2"
HBR120	29.5	34.2	225	3/4"
HBR140	39.0	41.6	260	1"

**Descrizione:**

Manicotti di protezione in Vinile di colore nero, ideati per la riduzione dello stress a flessione della tubazione nella zona della raccordatura.

**Temperatura di esercizio:**

Da +5°C a +80°C Da +41°F a +176°F

**Description:**

black vinyl protection sleeves, suitable to reduce tube bending stress in the crimping area.

**Working Temperature:**

From +5°C to +80°C From +41°F to +176°F

### UTENSILE PER MICROFORATURA MANUALE / TOOL FOR MANUAL PIN-PRICKING



**Descrizione:**

Da utilizzarsi per applicazioni con passaggio gas (aria compressa, azoto, ecc.) in cui si richiede la microforatura manuale del rivestimento esterno del tubo. Lo strumento è molto maneggevole e permette di microforare il tubo in modo veloce sul luogo di utilizzo. Con una minima pressione si fa scorrere lo strumento lungo la ricopertura del tubo ottenendo una perfetta microforatura della superficie esterna. L'attrezzo, grazie al fatto di essere piccolo e leggero è adatto sia per i tubi in gomma che per quelli termoplastici.

**Caratteristiche Tecniche:**

Dimensioni: L 260 x Ø 45 x Ø 30 mm

Campo d'impiego: da Ø 11.5 mm a Ø 50 mm

Peso: 0.6 Kg

Utensile per microforatura manuale cod. PRPPT1

**Description:**

To be used for gas conduction applications (compressed air, nitrogen, etc.) where the hose's exterior covering requires manual micro drilling. This tool is very handy and allows you to micro drill the tube quickly and on site. Slide the tool using only slight pressure along the tube's covering to perfectly micro drill its outer surface. Thanks to the fact that this tool is small and lightweight, it is suitable both for rubber and thermoplastic hoses.

**Technical Features:**

Sizes: L 260 x Ø 45 x Ø 30 mm

Working range: from Ø 11.5 mm to Ø 50 mm

Weight: 0.6 Kg

Tool for manual pin-pricking p/n PRPPT1

## ACCESSORI

### PINZE TAGLIA TUBO / TUBE CUTTER



Codice / Part Nr.	Descrizione / Description
PZG1	Pinza in grado di tagliare tubi di diametro esterno massimo sino a 28.0 mm. / Tube cutter capable of cutting hoses with up to a maximum external diameter of 28.0 mm.
PZP1	Pinza in grado di tagliare tubi di diametro esterno massimo sino a 12 mm. / Tube cutter capable of cutting hoses with up to a maximum external diameter of 12 mm.
LMG1	Lame di ricambio per tagliatubo PZG1. / Replacement blades for tube cutter PZG1.
LMP1	Lame di ricambio per tagliatubo PZP1. / Replacement blades for tube cutter PZP1.

## SPLITTING TOOLS

### ELENCO DEI COMPONENTI / LIST OF PARTS:

- 1) valigetta / carrying case
- 2) Splitting Tools (size -4, -5, -6, -8)
- 3) chiave esagonale / Allen wrench
- 4) cacciavite a stella / Phillips screwdriver
- 5) lame di ricambio / replacement blades
- 6) istruzioni / instructions

Su richiesta è possibile personalizzare il logo e la serigrafia della valigetta.

On request customizable logo and screen printing on the carrying case.



La separazione dei tubi binati mediante l'utensile Splitting Tool diventa una procedura semplice ed affidabile per ottenere velocemente ed in totale sicurezza due tubi singoli separati, pronti per la raccordatura.

Grazie alla lama a doppio tagliente inserita all'interno dell'utensile Splitting Tool, il tubo viene perfettamente guidato nella separazione, riducendo al minimo la possibilità di danneggiare la cover del tubo, come invece spesso avviene utilizzando altri utensili disponibili in commercio.

La lama è inoltre protetta da urti e cadute accidentali e previene possibili ferimenti involontari dell'operatore.

Usate sempre prodotti originali ZEC per avere la massima garanzia di sicurezza e di affidabilità.

The separation of twinned hoses using the Splitting Tool becomes a simple and reliable procedure in order to get quickly and in total safety two separate single hoses, ready for fittings.

Thanks to the double-edged blade put inside the Splitting Tool, the hose is perfectly guided into the separation, minimizing the risk of damaging the hose cover, as often happens using other tools available on the market.

The blade is also protected from accidental bumps and falls and it prevents possible involuntary injuries of the operator.

Always use original ZEC products to ensure maximum safety and reliability.

#### Dimensioni del kit (mm):

337 x 290 x 84

Peso complessivo del kit: 1.6 kg

#### Materiale della valigetta:

- esterno in polipropilene (PP)
- interno in spugna sagomata / bugnata

#### Materiale degli sbinatori:

- corpo in poliammide (PA12) nera
- lama in acciaio temprato

#### Codice kit: STNK1

#### Compatibilità con tubazioni ZEC:

- Serie OL7 / VE7
- Serie OL7S
- Serie OL7PL
- Serie OL7MP / VE7MP
- Serie OL8 / VE8
- Serie MTH1 / MT1
- Serie MTH1P

#### Kit dimensions (mm):

337 x 290 x 84

Kit total weight: 1.6 kg

#### Carrying case material:

- outside in polypropylene (PP)
- inside in shaped/ashlar foam

#### Splitting tools material:

- body in black polyamide (PA12)
- blade in hardened carbon steel

#### Kit Code: STNK1

#### Compatibility with ZEC hoses:

- OL7 / VE7 Series
- OL7S Series
- OL7PL Series
- OL7MP / VE7MP Series
- OL8 / VE8 Series
- MTH1 / MT1 Series
- MTH1P Series

## ACCESSORIES

### PRESSE MANUALI E PNEUMATICHE / MANUAL AND PNEUMATIC PRESS



PRESSA MANUALE PMZ47 / MANUAL PRESS PMZ47



PRESSA PNEUMATICA PPZ47 / PNEUMATIC PRESS PPZ47

DATI TECNICI / TECHNICAL DATA	CODICE / CODE	
	PMZ47	PPZ47
FORZA DI PRESSATURA / CRIMPING FORCE	100 TON (110 US TONS)	100 TON (110 US TONS)
CAPACITÀ / CAPACITY	1"	1"
Ø MASSIMO / MAX Ø	46 mm* (1.811")	46 mm* (1.811")
APERTURA MORSETTI / DIE OPENING	Ø + 20 mm (Ø + 0.788")	Ø + 20 mm (Ø + 0.788")
RACCORDI A 90° / 90° FITTINGS	3/8"	3/8"
DIMENSIONI PRESSA LxPxH / DIMENSIONS LxWxH	390x510x300 mm (15.3"x20.7"x11.8")	380x430x400 mm (14.9"x16.9"x15.7")
PESO / WEIGHT	32 Kg (71 Lbs)	38 Kg (84 Lbs)
SFORZO SULLA LEVA / REQUIRED EFFORT ON THE LEVER	30 Kg (66 Lbs)	-
ALIMENTAZIONE PNEUMATICA / PNEUMATIC INPUT	-	max 7 Bar (100 Psi)
CILINDRO / CYLINDER	SEMPLICE EFFETTO / SINGLE ACTING	SEMPLICE EFFETTO / SINGLE ACTING
<b>ACCESSORI INCLUSI / INCLUDED ACCESSORIES</b>		



CASSETTO PORTA MORSETTI / DIE HOLDER DRAWER

OLIO 2,5 LT. (per PRESSA PNEUMATICA) / 2,5 LT. OIL (for PNEUMATIC PRESS)

MORSETTI / DIES#	PMZ47 - PPZ47											
DIAMETRO MORSETTI / DIE SET DIAMETER	6	8	10	12	14	16	19	22	25	29	39*	
LUNGHEZZA MORSETTI / DIE LENGTH	55	55	55	55	55	55	55	55	65	65	64	
CODICE / PART N. MPRESSA-	PPZ476	PPZ478	PPZ4710	PPZ4712	PPZ4714	PPZ4716	PPZ4719	PPZ4722	PPZ4725	PPZ4729		-

\*Porta morsetti - Die holder

#Un diametro di morsetti a scelta compreso nella fornitura della pressa - One die set chosen by customer included with the press

### ACCESSORI / OPTIONAL



UTENSILE CAMBIO MORSETTI / TOOL FOR DIE CHANGE  
Part. N.: MPZ47UCM

## ACCESSORI

### TAPPI DI SERVIZIO / SERVICE PLUGS



Manufactured by



**SERVICE PLUG** è un innovativo e pratico sistema per i professionisti della manutenzione e in generale per tutti gli operatori tecnici.

Studiato per eliminare la fuoriuscita di oli o sostanze chimiche dai tubi, **SERVICE PLUG** evita la contaminazione dei tubi e dei fluidi durante le operazioni di manutenzione e pulizia degli impianti. Inoltre, contribuisce a salvaguardare l'ambiente e mantenere pulite le aree di lavoro.

**SERVICE PLUG** is an innovative system for maintenance operations on production lines.

This solution has been developed to prevent fluids leakage, but especially to avoid possibility of contamination on hoses, pipes, systems during maintenance or line cleaning operations.

Moreover **SERVICE PLUG** helps to protect the environment and to maintain clean workspaces.



#### Caratteristiche

- Materiale: NBR
- Temperatura di esercizio: da -25° C a +90° C
- Resistente ai maggiori oli e sostanze chimiche
- Per sistemi non pressurizzati
- Non contengono silicone
- I tappi sono solidi, ma è possibile tagliarli se necessario
- Sono riutilizzabili più e più volte

#### Features

- Material: NBR rubber
- Temperature range: -25° C to +90° C
- Resistant to most oils and chemicals
- For non-pressurised systems only
- Does not contain silicone
- Plugs are solid but can be cut if necessary
- Re-usable

## ACCESSORIES

Tappo Plug	MICRO	STD	XL
Diametro tubo Hose diameter	Ø from 1 to 10 mm	Ø from 5 to 22 mm	Ø from 13 to 42 mm
			

### Confezioni / Package

Colore verde per settore oleodinamico e industriale, colore bianco per settore alimentare.  
Green for hydraulic and industrial applications, white for food applications.

### Modelli disponibili / Available sizes

Descrizione Description	MIXBOX 4 MICRO + 4 STD + 2 XL	20 MICRO	10 STD	4 XL
Codice / Code	TAPPOSPMIXBOX	TAPPOSPMICRO	TAPPOSPSTD	TAPPOSPXL
	   2x Ø 13 - 42    4x Ø 5 - 22    4x Ø 1 - 10	 20x Ø 1 - 10	 10x Ø 5 - 22	 4x Ø 13 - 42

### Istruzioni / Instructions

1. Inserire / Insert



2. Spingere / Push



3. Spingere e girare / Push and Twist



# INDICAZIONI DI MONTAGGIO INSTALLATION INSTRUCTIONS (SAE J1273 - ISO 8331)

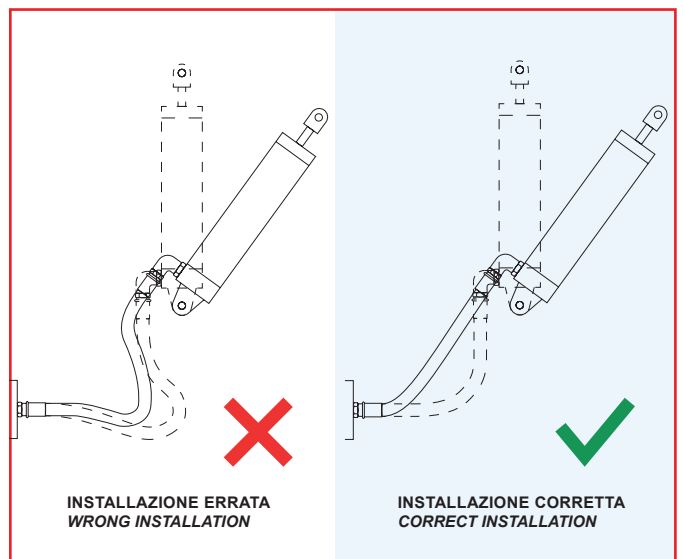
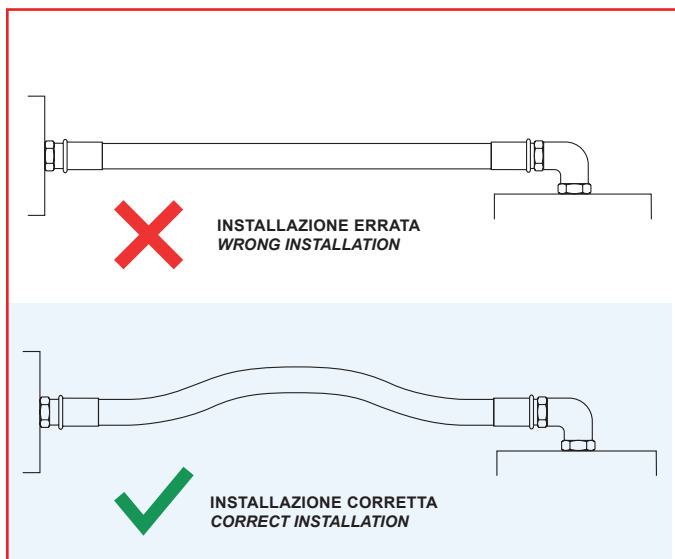
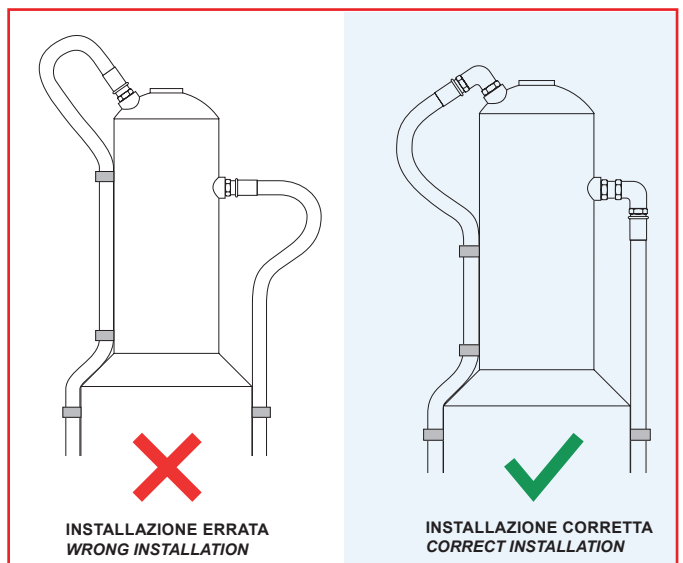
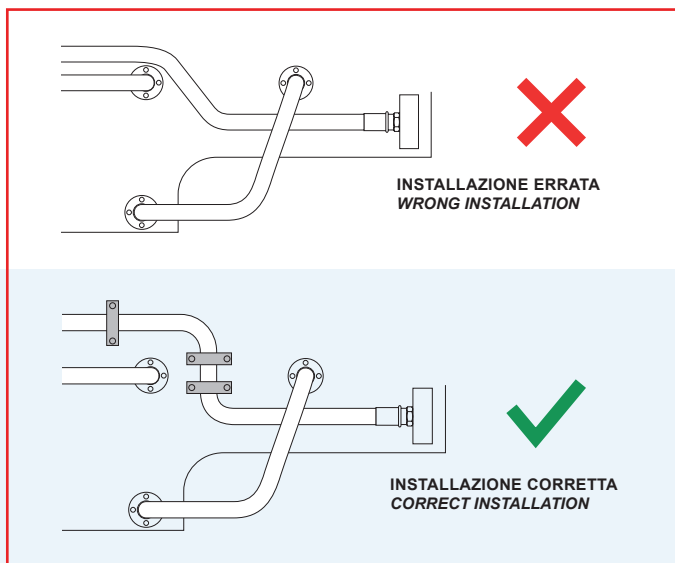
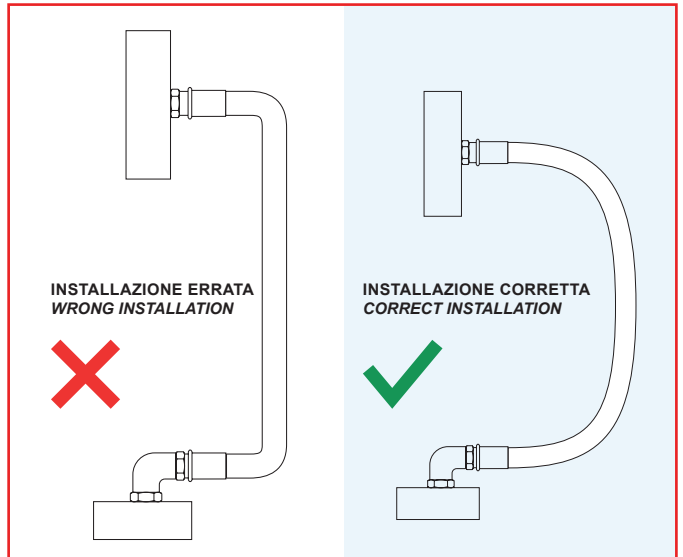
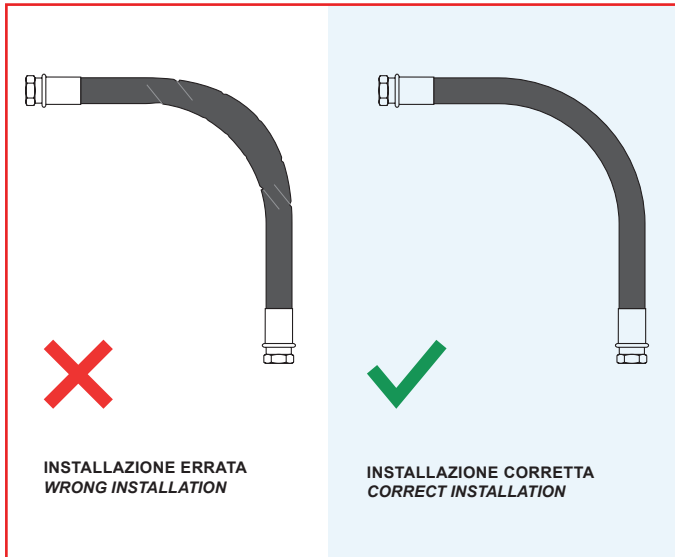



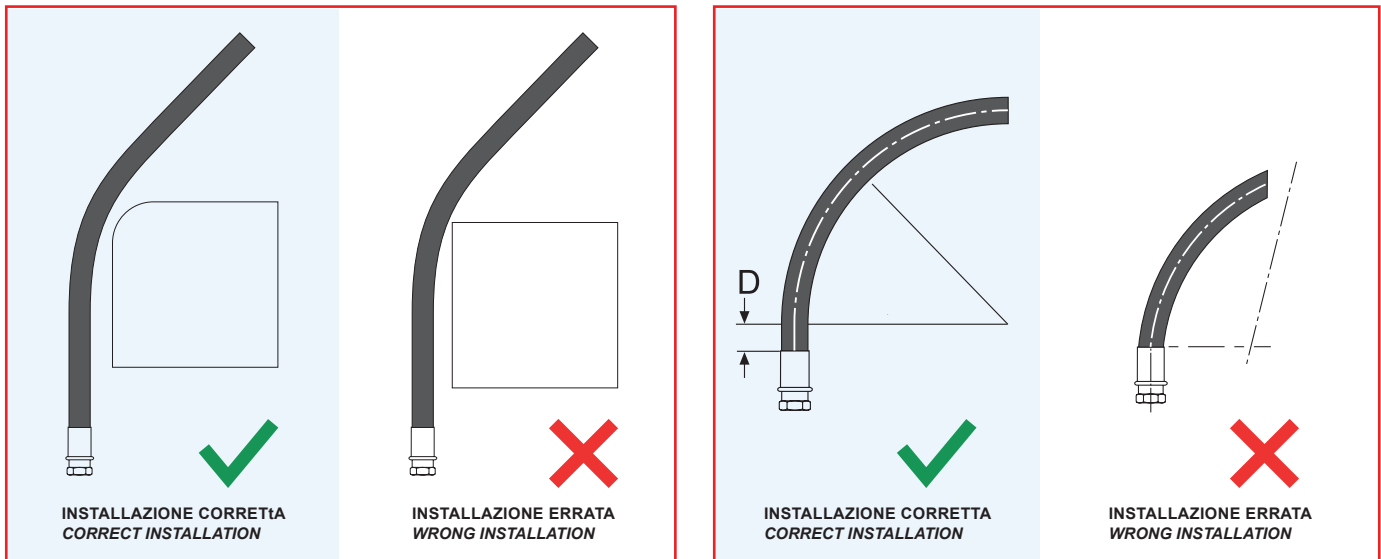

## ISTRUZIONI E DATI DI RACCORDATURA CRIMPING DATA AND INSTRUCTIONS

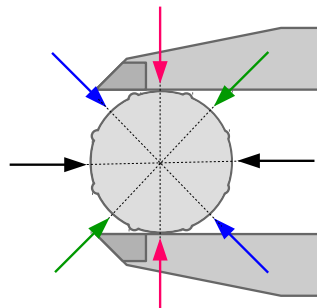

Per una corretta e sicura operazione di raccordatura raccomandiamo l'uso di raccordi e boccole ZEC; istruzioni e diametri di pressatura sono disponibili e sempre aggiornati in Area Riservata sul sito ZEC: [www.zecspa.com/it/area-riservata](http://www.zecspa.com/it/area-riservata)

For a correct and safe crimping operation, we recommend the use of ZEC ferrules and fittings; proper instructions and crimping diameters are available and always updated into Restricted Area on ZEC's web page: [www.zecspa.com/en/reserved-area](http://www.zecspa.com/en/reserved-area)

Le immagini e i valori menzionati in questo documento sono forniti a titolo puramente indicativo al fine di consentire una prima valutazione sulle possibilità di impiego dei prodotti. La Nostra produzione potrà essere variata senza impegno di alcun preavviso alla Nostra clientela.

Si raccomanda di verificare sul sito [www.zecspa.com](http://www.zecspa.com) la presenza di possibili adeguamenti per scaricare le schede tecniche di prodotto aggiornate.

**È responsabilità del cliente verificare che i tubi e i raccordi siano adatti alla propria applicazione e soddisfino le specifiche e gli standard richiesti.**

Per condizioni di vendita: [www.zecspa.com/it/condizioni-general-di-vendita](http://www.zecspa.com/it/condizioni-general-di-vendita)

The images and values indicated in the present document are to be intended only as an indication, with the purpose of permitting the customer a first evaluation of the products application possibilities. Our production can be modified without any obligation of prior notice to our customers.

Therefore we recommend to consult our website [www.zecspa.com](http://www.zecspa.com) for the latest version of the technical data sheets.

**It's the Customer's responsibility to check that hoses and fittings are suitable for his application and meet the required specifications and standards.**

For Terms of Sale please refer to [www.zecspa.com/en/general-conditions-of-sale](http://www.zecspa.com/en/general-conditions-of-sale)



ZEC S.p.A.  
Via Lungolorno 11, 43052 Colorno (PR) - Italy  
Tel. +39 0521 816631 - Fax +039 0521 816772

[www.zecspa.com](http://www.zecspa.com)  
[info@zecspa.com](mailto:info@zecspa.com)



THERMOPLASTIC TUBING AND HOSES





## LubeTeam Hydraulic S.r.l.

*Administration and Headquarter:*

Via Tufara Scautieri, 6

83018 - San Martino Valle Caudina (AV)

*Office and Warehouse:*

S.S. 7 Appia, Km. 237,00

82011 - Airola BN

ITALY

Tel. +39 0823 950 994

Fax +39 0823 412 546

[www.lubeteam.it](http://www.lubeteam.it) [info@lubeteam.it](mailto:info@lubeteam.it)

Italian VAT / C.F. e P.IVA: 01251720627

Follow us



This document is the property of LubeTeam Hydraulic S.r.l. All data reported here are for the exclusive use of the Receiver. Reproduction is not authorized without writing permission, in all or in part of the content of this document, in accordance to Law 633 art. 171, dated April 22, 1941.

Il presente documento è di proprietà della LubeTeam Hydraulic S.r.l. I dati riportati sono per esclusivo del destinatario. La riproduzione, di tutto o in parte, non è autorizzata senza permesso scritto secondo l'art. 171 della L. 633 del 22 Aprile 1941.